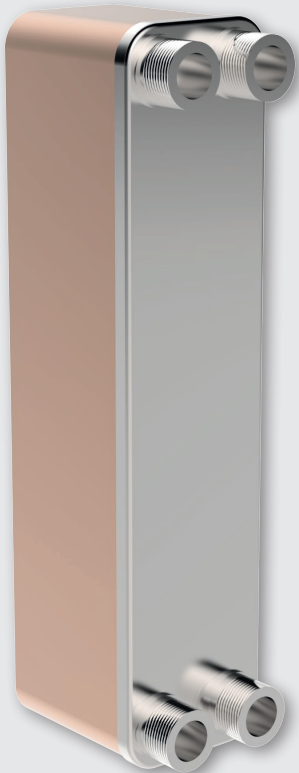
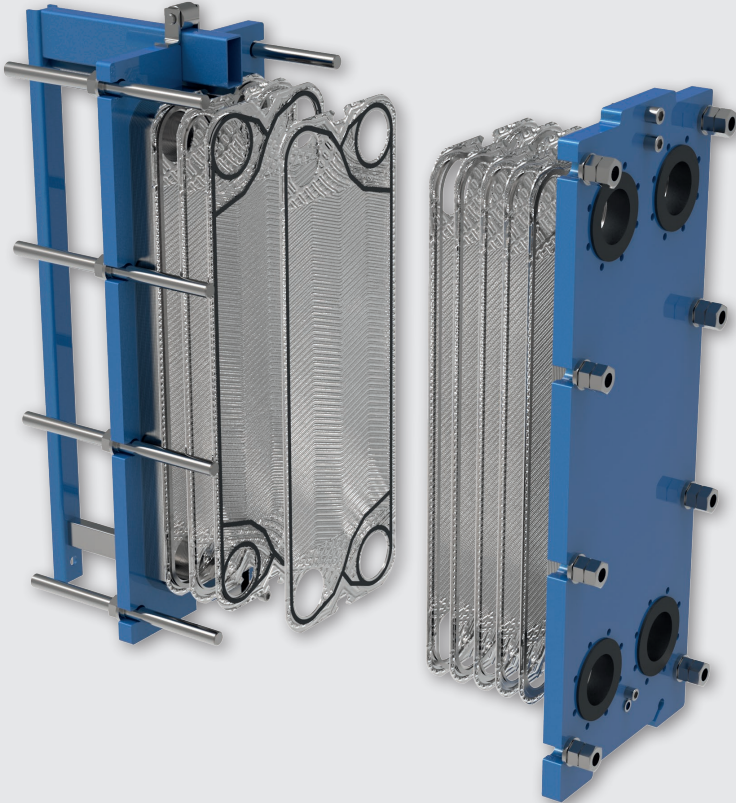

Plate Heat Exchangers



Industrial

Fiorini has supplied the plate heat exchangers **that equip the GST3 system** aimed at the cooling of the transfer and launch stations of the Ariane Sud.



Gasketed and brazed plate heat exchangers

Customized and efficient options for all your requirements for heat exchanging

The gasketed plate heat exchangers (K and F series) and brazed plate heat exchangers (P and WP series) are the option for someone who demands efficiency and trustworthiness. Our thirty years' experience in this sector makes it possible to meet every requirement, in a residential as well as an industrial setting. We guarantee support during the design phase, the installation phase and after sale.

Gasketed exchangers

Our gasketed plate heat exchangers have the following features:

- designed to improve the exchange performance and to reduce and simplify the maintenance operations;
- use of high quality materials which can be paired with a wider range of fluids and applications;
- custom made production
- design of modular and customized solutions;
- easy to inspect

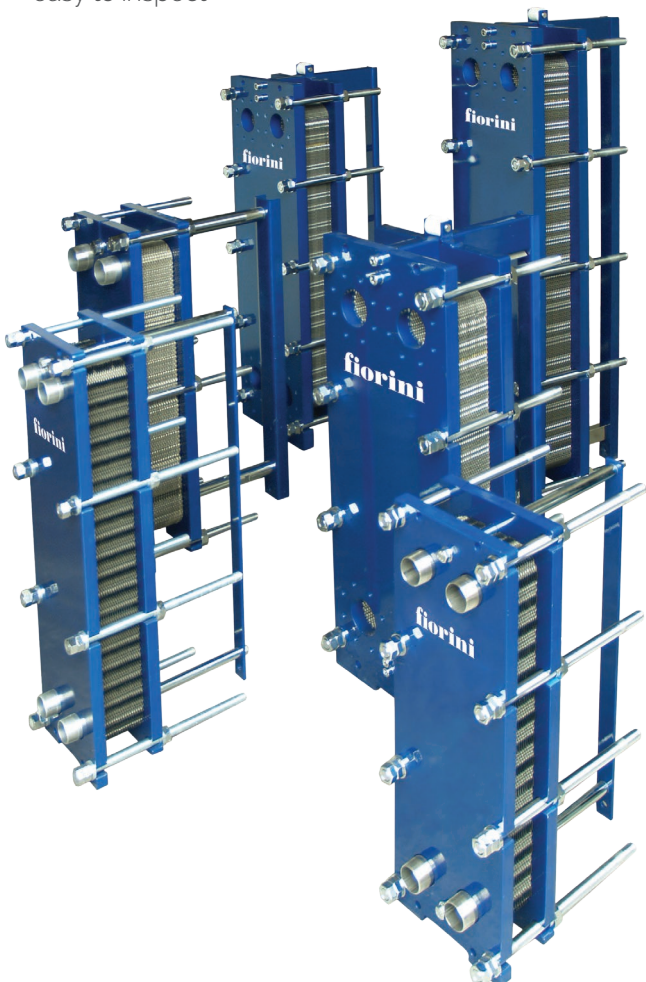

Brazed exchangers

The quality of the parts, as well as the brazing process makes it possible to attach the plates without using gaskets. This is a huge advantage because it makes the exchanger compact and resistant to high temperatures and pressure.



Gasketed plate heat exchangers K and F series

The heat exchangers (K and F series) are designed and manufactured with materials and applications which guarantee high, durable efficiency standards in residential applications as well as industrial processes.

- The plates are made in high quality materials which makes it possible to reach an excellent overall heat exchange coefficient and guarantees resistance against corrosion;
- The plates can be manufactured with several corrugations which improve the exchange performance in function of the operative conditions (fluid type, viscosity). Their particular conformation makes the fluid in the device move turbulently and guarantees an elevated heat exchange coefficient.
- The lining is available in several materials, adapted to the different applications (gasoline, oil, alimentary fluids, aggressive fluids, high temperature fluids, etc.) and desired performance;
- The frame is made of varnished carbon steel, designed in such a way that it can be easily accessed, inspected and maintained;
- All exchangers are tested (leakage test) before dispatch in order to verify possible losses.

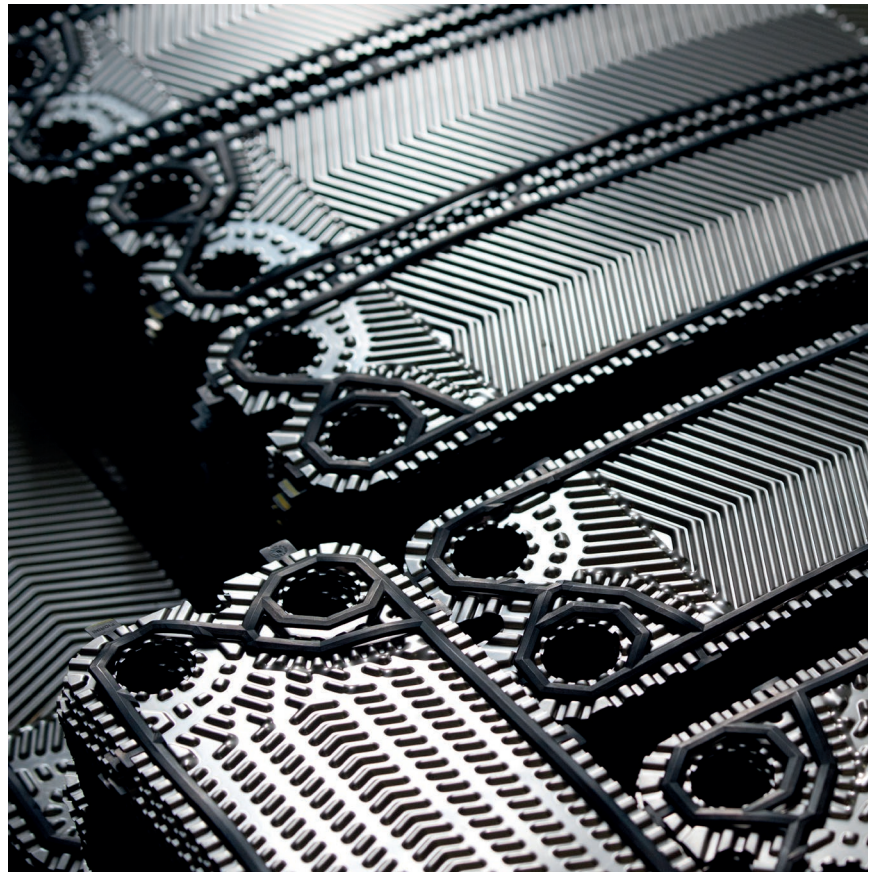
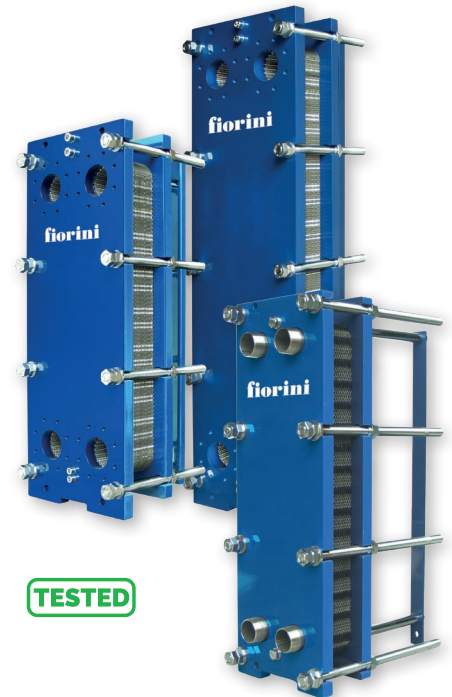

Gasketed plate heat exchangers K and F series

Environment and sectors of application

Wherever a heat exchange between two fluids takes place, the Fiorini plate heat exchangers guarantee a series of significant advantages:

- high efficiency
- long life span
- low cost
- compact dimensions
- possibility to expand
- easy maintenance
- trustworthiness

The Fiorini heat exchangers are products of reference in the residential and industrial sectors (HVAC, food, chemical, renewable energy, cooling, oil and gas).

They offer the best options for numerous applications, such as:

- DHW production
- heat exchanging in heating systems
- teleheating
- pool water heating
- solar power systems
- heating/cooling of alimentary fluids (milk, beer, wine...)
- cooling of machines
- recuperation of heat from industrial processes
- hydraulics

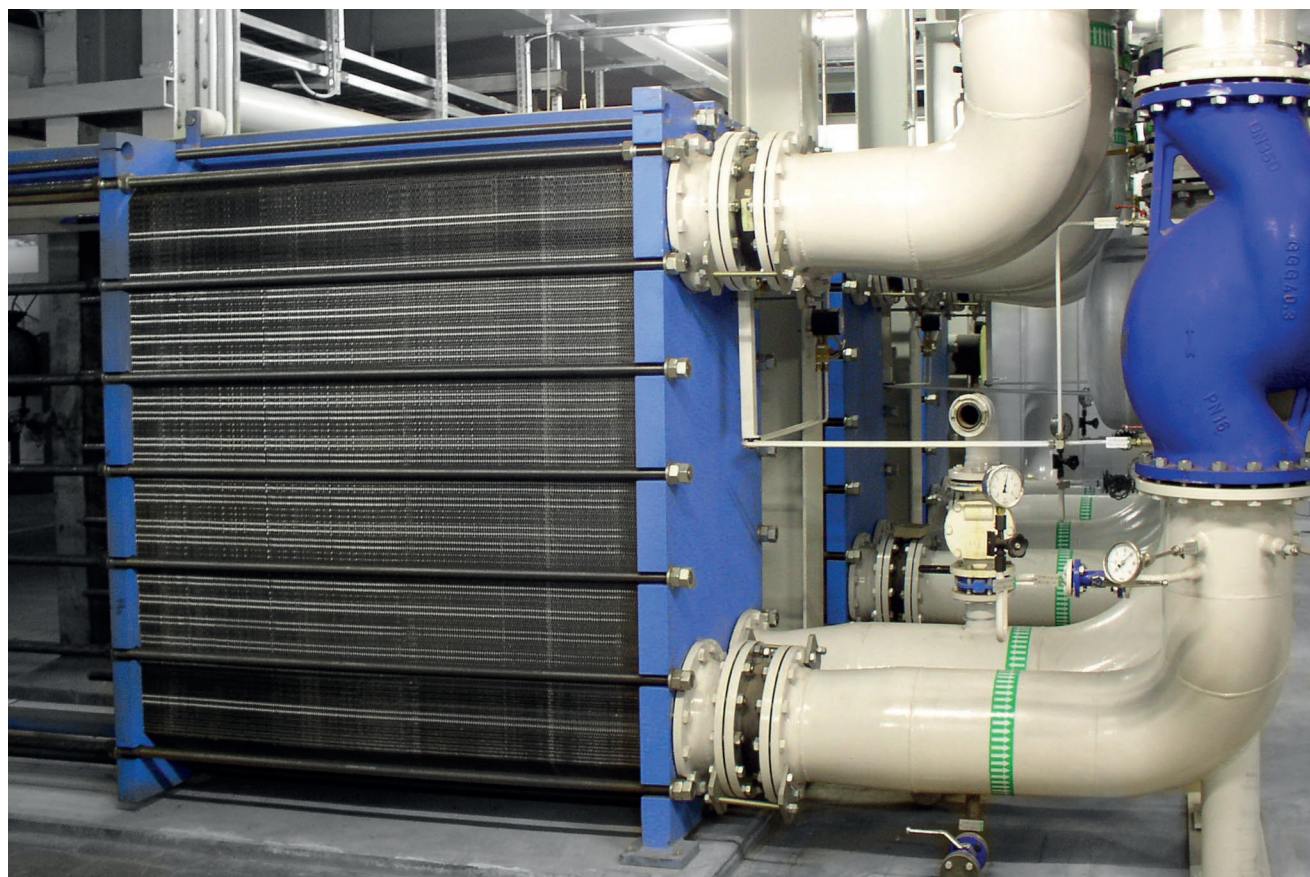

Principles

Single passage

In the version with a single passage the fluid which runs through the exchangers, goes through one canal (the space between two adjacent plates). This is the most commonly used layout.

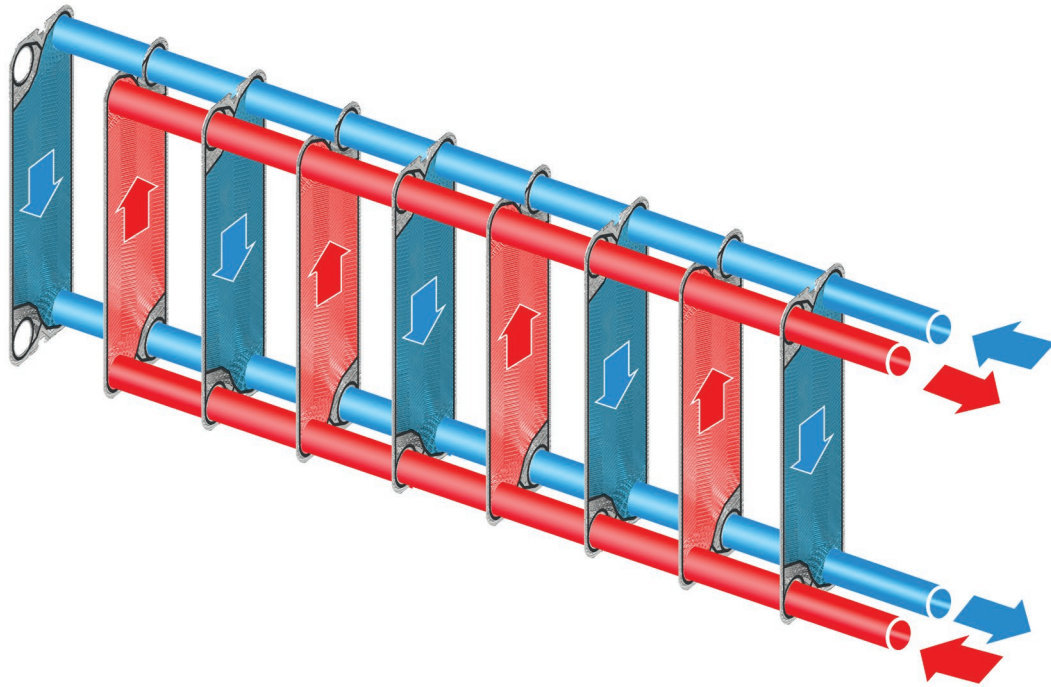

Multiple passage

In this version the thermal length of the exchanger increases with the number of passages (double length with 2 passages, triple length with 3 passages, etc.) This solution is necessary when there is a very low temperature difference between the primary and the secondary circuit.

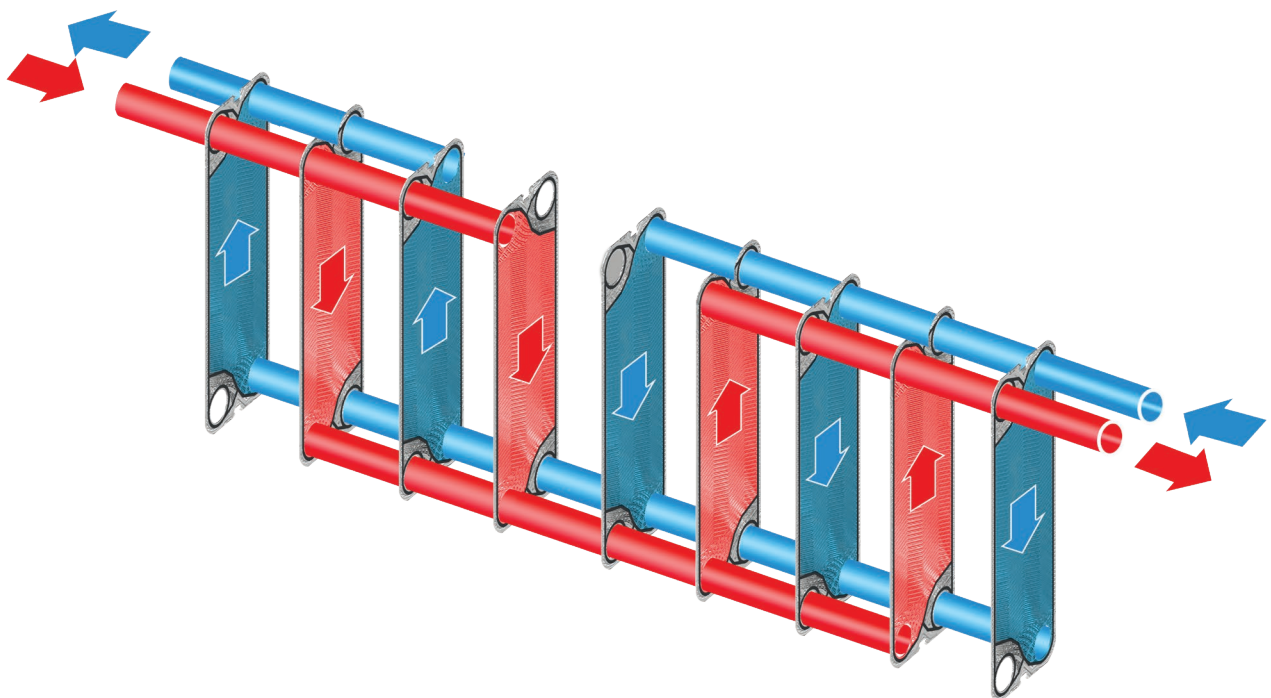

Main components

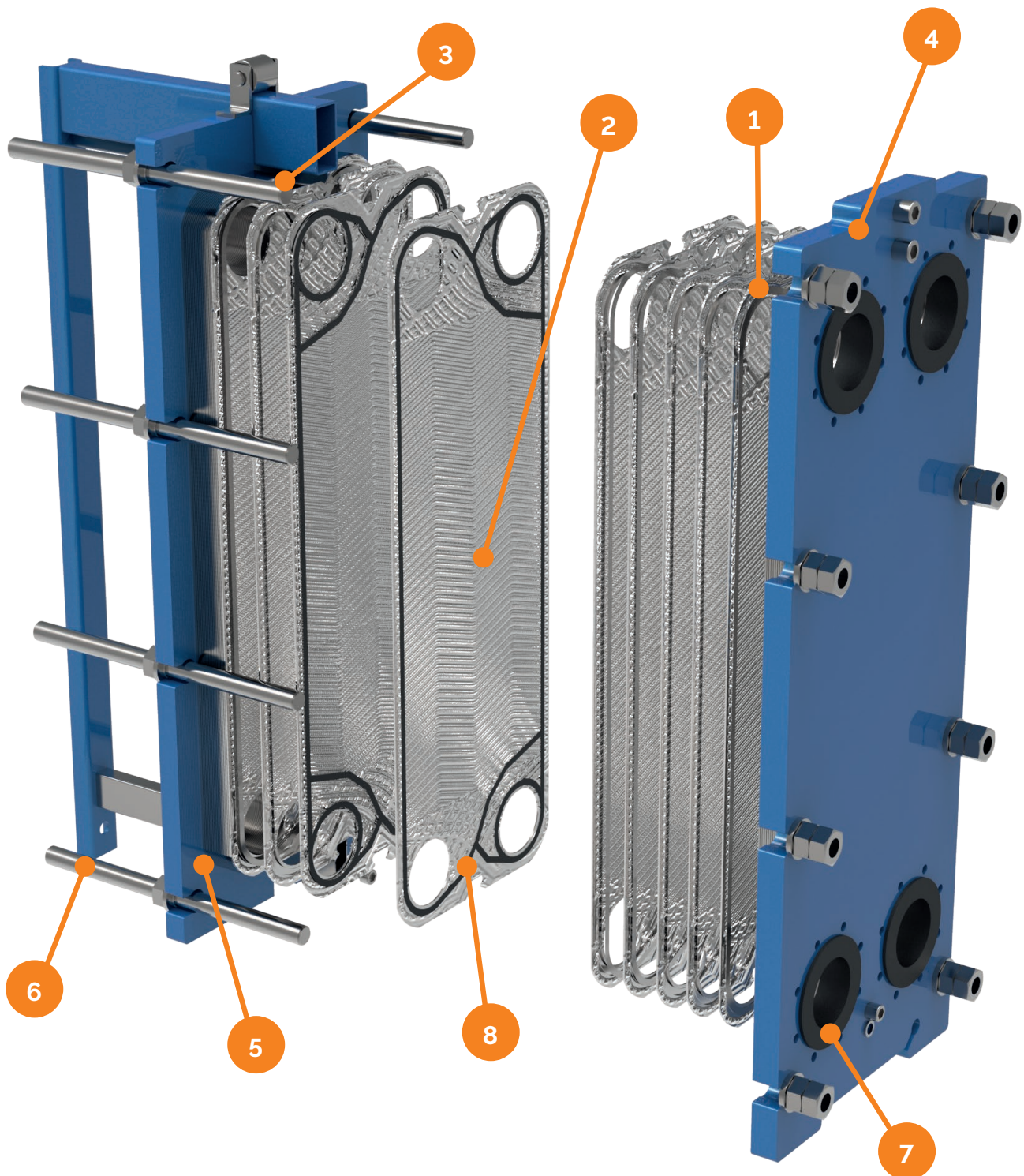

Legend

1. anterior plate
2. mid plate
3. posterior plate
4. fixed cover
5. movable cover
6. tie rod
7. coupling
8. gaskets

Fiorini Plate heat exchangers are designed to ease access and maintenance. Furthermore, its modularity allows to increase number of the plates according to the heat exchange requirements.

Gasketed plate heat exchangers

Our range

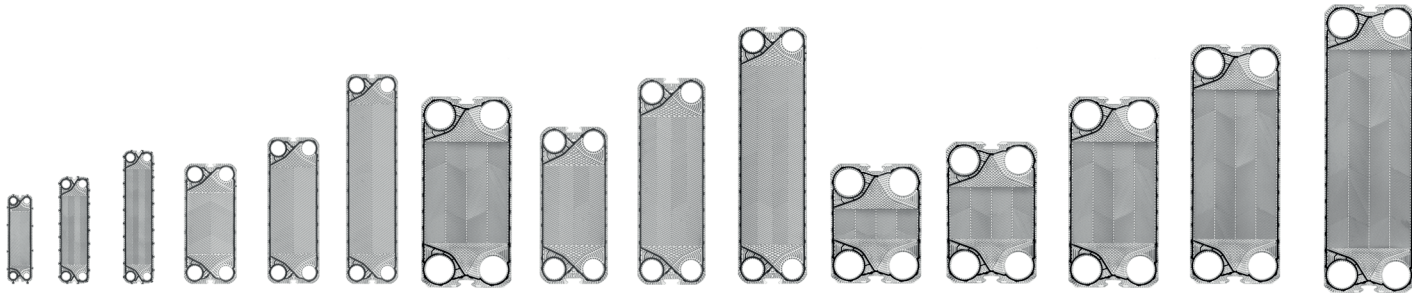

Model	DN 32		DN 40		DN 50			DN 100				DN 150	
	K042/H1	K080/H2	F10	F16	F22	F206	F31	F50	F71	F41-42	F60-F62		
Plate surface (m ²)	0,042	0,085	0,10	0,15	0,22	0,21	0,30	0,50		0,40	0,60		
Nominal pressure	PN10/PN16	PN10/PN16	PN10/PN16/PN25			PN10/PN16/PN25				PN10/PN16/PN25			
Available corrugations	H	H - V	H - L	H - L	H - L	H - L	H - L	H - L	H - L	H - L	H - L		
Standard coupling	1"1/4 GAS M	1"1/2 GAS M	2" GAS M			DN 100 UNI PN16				DN 150 UNI	PN16		
PP (mm)	NPx3,1+2	NPx3,05+2	NPx 2,9+3	NPx 2,9+3	NPx 2,9+3	NPx 3,1 *	NPx 3,1 *	NPx 3,1 *	NPx 3,1 *	NPx 3,5 *	NPx 3,5 *		
A (mm)	470	725	733	932	1132	1160	1332	1826	2320	1470	1835		
B (mm)	200	250	310	310	310	480	480	480	480	620	620		
C (mm)	380	555	494	694	894	719	894	1388	1882	941	1306		
D (mm)	68	100	126	126	126	225	225	225	225	290	290		
E (mm)	45	90	128	128	128	204	204	204	225	290	290		

* With rubber liner add 1.5 mm

➤ Special executions are available on request

Couplings

Primary: Inlet F1 - Outlet F4

Secondary: Inlet F3 - Outlet F2

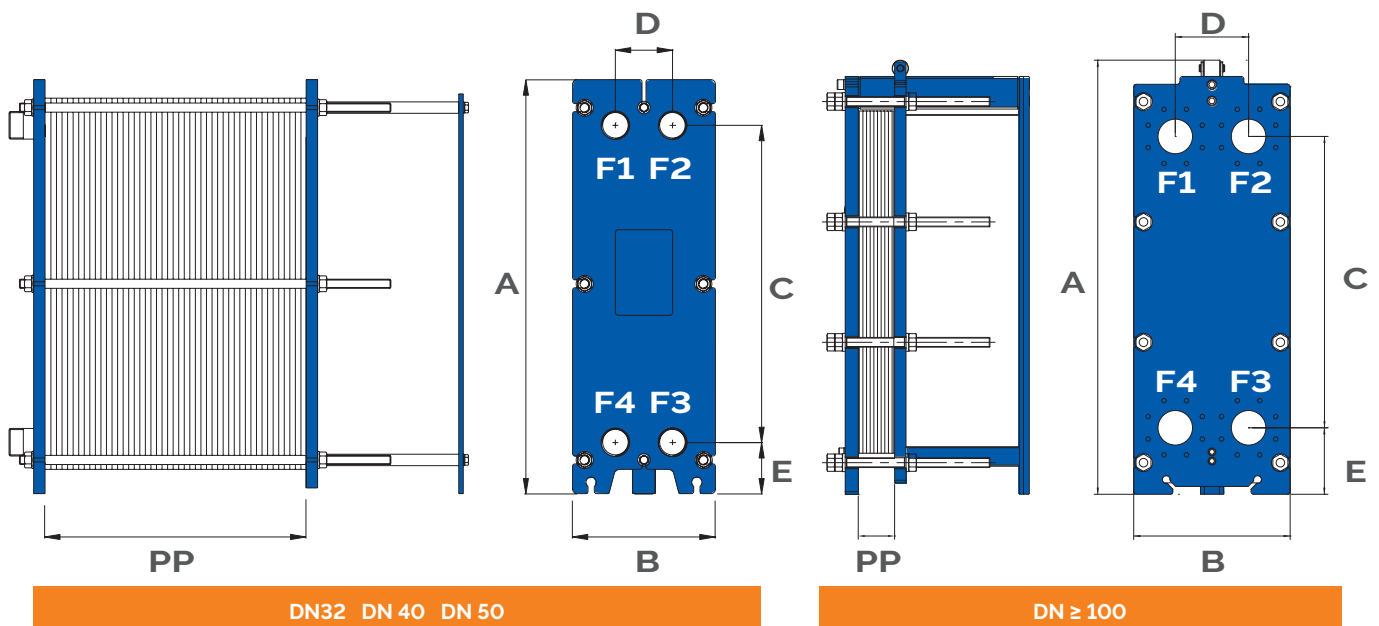

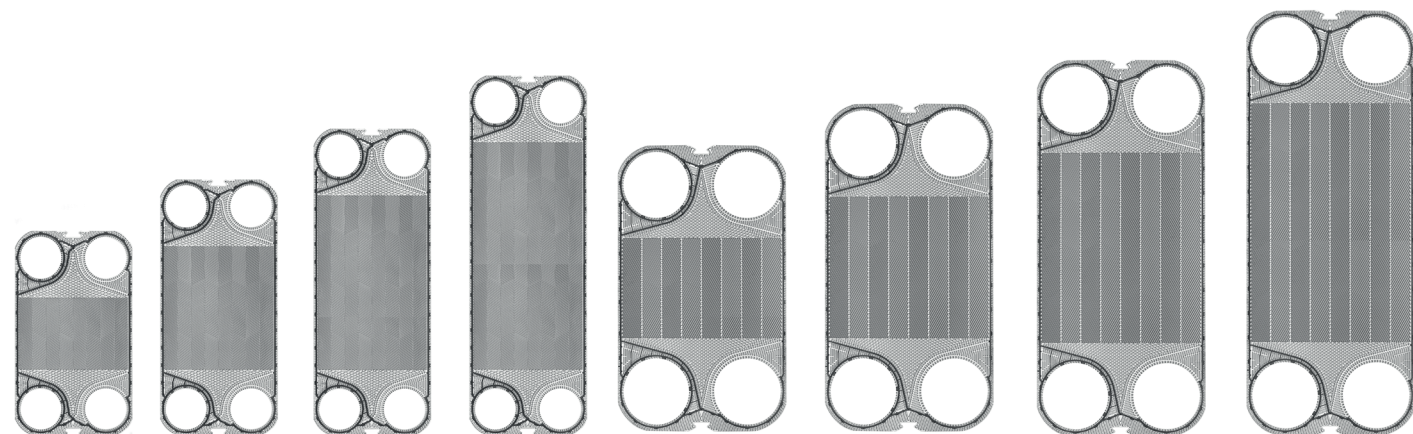

DN 150		DN 200				DN 300				DN 500			
F80-F82	F112	F405	F70	F100	F130	F81	F120	F160	F190	F150	F200	F250	F300
0.80		0.41	0.68	1.00	1.30	0.80	1.20	1.60	1.90		2.00	2.50	3.00
PN10/PN16/PN25		PN10/PN16/PN25				PN10/PN16/PN25				PN10/PN16/PN25			
H - L	H - L	H - L	H - L	H - L	H - L	H - L	H - L	H - L	H - L	H - L	H - L	H - L	H - L
DN 150 UNI	PN16	DN 200 UNI PN16				DN 300 UNI PN16				DN 500 UNI PN16			
NPx 3.5 *	NPx 3.5 *	NPx 3.1 *	NPx 3.1 *	NPx 3.1 *	NPx 3.1 *	NPx 3.8 *	NPx 3.8 *	NPx 3.8 *	NPx 3.8 *	NPx 4.1 *	NPx 4.1 *	NPx 4.1 *	NPx 4.1 *
2200	2687	1380	1740	2100	2460	930	2320	2710	3100	2500	2855	3211	3567
620	620	760	760	760	760	980	980	980	980	1370	1370	1370	1370
1671	2157	770	1130	1490	1850	1100	1490	1879	2267	1466	1822	2178	2534
290	290	395	395	395	395	480	480	480	480	672	672	672	672
290	290	395	395	395	395	480	480	480	480	672	672	672	672

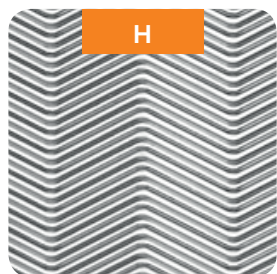

Corrugations

The plates are available with various corrugations and can be combined in order to reach better performances.

H: this type of corrugation maximizes the thermal power which is exchanged

L and V: these versions minimize the pressure loss

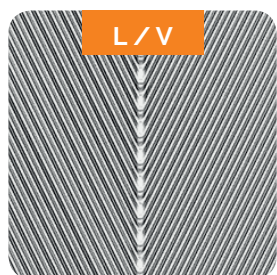

Available materials

Model	Plates			Gaskets			Covers		Tie rod	
	AISI 304	AISI 316L	TITANIUM	NBR	EPDM	VITON	PAINTED STEEL	AISI 304	GALVANIZED STEEL	AISI 304
K serie	-	✓	✓	✓	✓	-	✓	○	✓	○
F serie (up to DN50)	-	✓	✓	✓	✓	○	✓	○	✓	○
F serie (from DN100)	○	✓	✓	✓	✓	○	✓	○	✓	○

Legend: ✓ standard ○ upon request - not available

F serie available upon request with plates in the following materials; 245 SMO, AISI 904L, ALLOY C276.

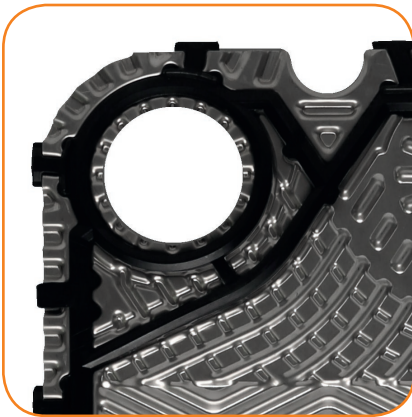

Gaskets

The gaskets are attached to the plates through a clip-on system, which ensures hygiene and easy maintenance and does not use glue and solvents. The particular conformation of the gaskets creates a double barrier and prevents accidental contamination of the two fluids, also in case of loss. The gaskets are available in various materials, to be used in function of the different user parameters:

- **NBR** (nitrile rubber): generally used with water, other liquids, oily mineral liquids T max 130C
- **EPDM** (ethylene-propylene rubber): broad range of use, such as with non-mineral oils, water and steam T max 150C
- **VITON** (fluoro rubber) extremely resistant to chemical substances or aggressive fluids (sulfuric acid, vegetal oil) and high temperatures (Tmax 195C)

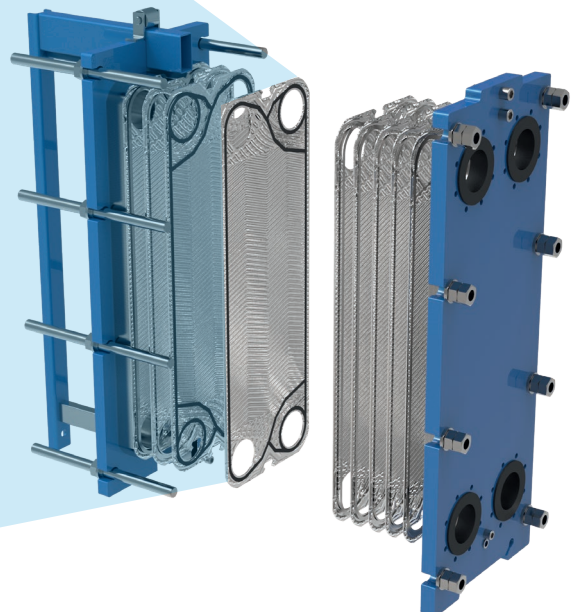
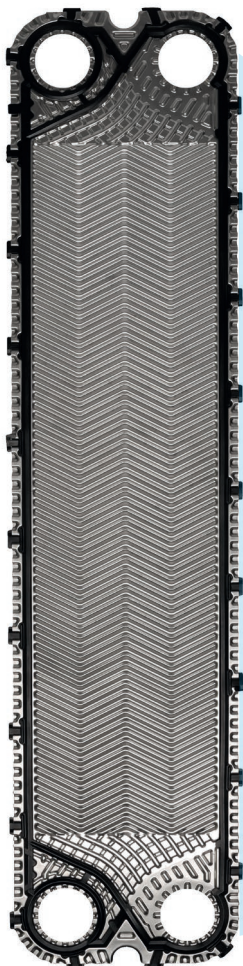

Fluid/material compatibility

In the table, some guidelines for the correct combination of materials are outlined.

Fluid type	Fluid	Plates			Gaskets		Couplings	
		AISI 304*	AISI 316L	TITANIUM	NBR	EPDM	STAINLESS STEEL	NYLON (TMAX 50°C)
WATER	water (tmax < 110°C)	✓	✓	✓	✓	✓	✓	✓
	water (tmax > 110°C)	-	✓	✓	-	✓	✓	-
	water demineralized	-	✓	✓	✓	-	✓	✓
	sea water (NaCl)	-		✓	✓	-	-	✓
	chlorinated water	-	✓	✓	✓	-	✓	✓
	thermal water	-		✓	-	✓		✓
	mineral water	-	✓	-	-	✓	✓	-
	steam < 4 bar	-	✓	-	-	✓	✓	-
WATER & GLYCOL	ethylene glycol (glycol < 30%)	✓	✓	✓	✓	✓	✓	✓
	ethylene glycol (glycol > 30%)	✓	✓	✓	-	✓	✓	✓
	propylene glycol (glycol < 30%)	✓	✓	✓	✓	✓	✓	✓
	propylene glycol (glycol > 30%)	✓	✓	✓	-	✓	✓	✓
HYDROCARBONS	diesel fuel	-	✓	✓	✓	-	✓	-
	kerosene	-	✓	✓	✓	-	✓	-
	Petroleum	-	✓	✓	✓	-	✓	-
	pure gasoline	-	✓	✓	✓	-	✓	-
	naphtha	-	✓	✓	✓	-	✓	-
OILS	sae oil	-	✓	✓	✓	-	✓	-
	oil iso vg	-	✓	✓	✓	-	✓	-
	diathermic oil	-	✓	✓	✓	-	✓	-
	hardening oil	-	✓	✓	✓	-	✓	-
	mineral oil	-	✓	✓	✓	-	✓	-
	synthetic oil	-	✓	✓	-	✓	✓	-
	olive oil	-	✓	✓	✓	-	✓	-
seeds oil	-	✓	✓	✓	-	✓	-	
ACIDS	sulfuric acid 20% (aqueous), 50°C	-	**	-	-	✓	-	✓
	hydrochloric acid 1% (aqueous), 20°C	-	**	-	-	✓	-	✓
	acetic acid 70°C	-	✓	-	-	✓	-	✓
	chromic acid 20%, 20°C	-	✓	-	-	✓	-	✓
FOOD	milk	✓	✓	-	✓	✓	✓	-
	wine, juice	✓	✓	-	✓	✓	✓	-
	beer	✓	✓	-	✓	✓	✓	-
	whiskey	✓	✓	-	✓	✓	✓	-
	wine vinegar	-	✓	-	-	✓	✓	-
	liquor	✓	✓	-	-	✓	✓	-
OTHER FLUID	acetone	-	✓	✓	-	✓	✓	-
	ethyl alcohol	-	✓	✓	-	✓	✓	-
	ethanol	-	✓	✓	-	✓	✓	-
	ethylene	-	✓	✓	✓	-	✓	-
	methanol	-	✓	✓	-	✓	✓	-

Legend: ✓ compatible - in compatible

* Only for closed circuits and with a chloride concentration less than 25 ppm and Tmax 80C

** Use 254 SMO - AISI 904 L - Alloy C276 plates

Couplings

Our gasketed plate heat exchangers can be manufactured with numerous kinds of couplings, threaded, with a free flange, with a welded flange and with liner. Liner is the coating in the shaft connection edges, that can be made of steel or rubber.

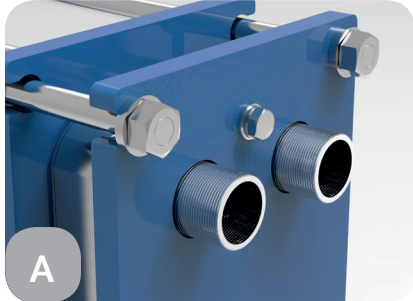

A
Threaded coupling
(steel or nylon)

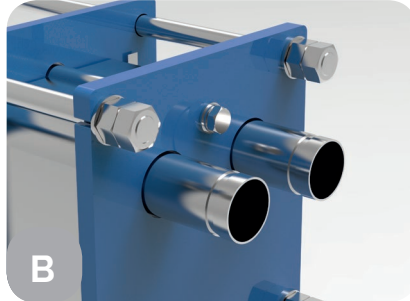

B
Victaulic coupling

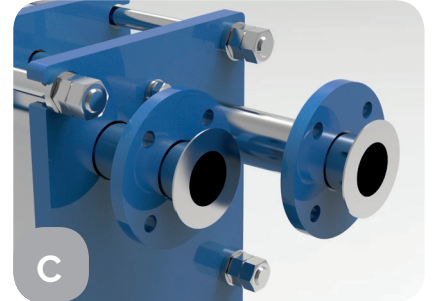

C
Free Flange coupling

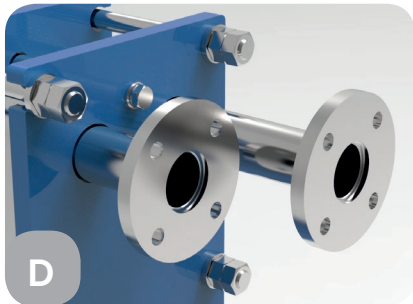

D
Welded Flange coupling

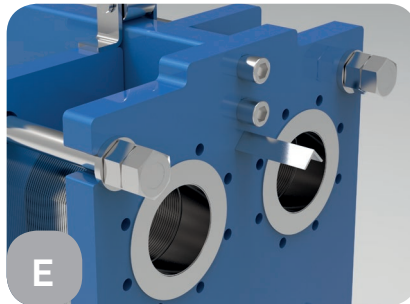

E
Metal Liner coupling

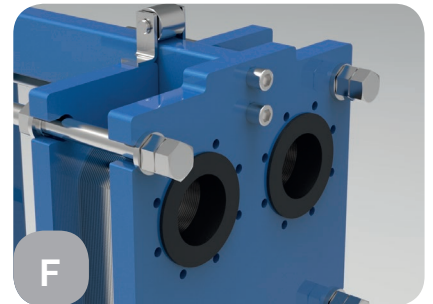

F
Rubber Liner coupling

Coupling compatibility

Model	A	B	C	D	E	F
K042	✓	✓	✓	✓	✓	✓
K080	✓	✓	✓	✓	✓	✓
F10	✓	✓	✓	✓	✓	✓
F16	✓	✓	✓	✓	✓	✓
F22	✓	✓	✓	✓	✓	✓
F206				✓	✓	✓
F31				✓	✓	✓
F50				✓	✓	✓
F71				✓	✓	✓
F41-42				✓	✓	✓
F60-62				✓	✓	✓
F80-82				✓	✓	✓
F112				✓	✓	✓
F405				✓	✓	✓
F70				✓	✓	✓
F100				✓	✓	✓
F130				✓	✓	✓
F81				✓	✓	✓
F120				✓	✓	✓
F160				✓	✓	✓
F190				✓	✓	✓
F150				✓	✓	✓
F200				✓	✓	✓
F250				✓	✓	✓
F300				✓	✓	✓

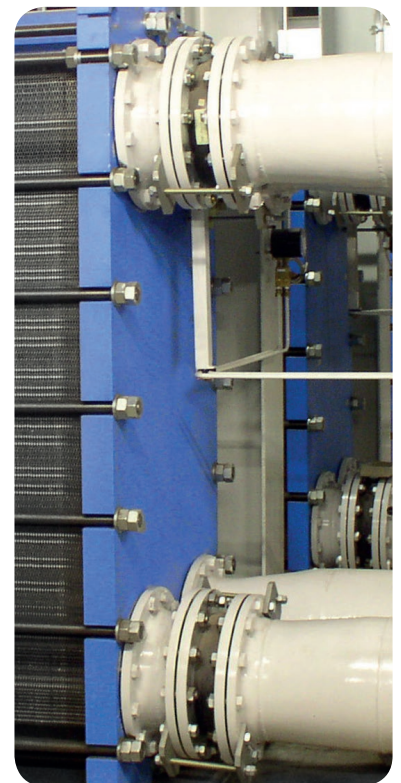

Accessories

Insulation box, Condensate collection tub, Feet set

For **models K042 e H1** it is available an **thermoformed** insulation box, removable by coupling with velcro strips (**feet set included**).

Model	Plates threshold	Thermoformed Insulation Box	
		Code	Price
K042	up to 64 plates	843090028X	
H1	up to 64 plates	843090028X	



Legend

1. Aluminium Insulation Box: Available for the entire range, it is made of an aluminium structure covered with insulating material.
2. Condensate collection tank: **mandatory in applications in refrigeration and cooling plants**
3. Support feet set

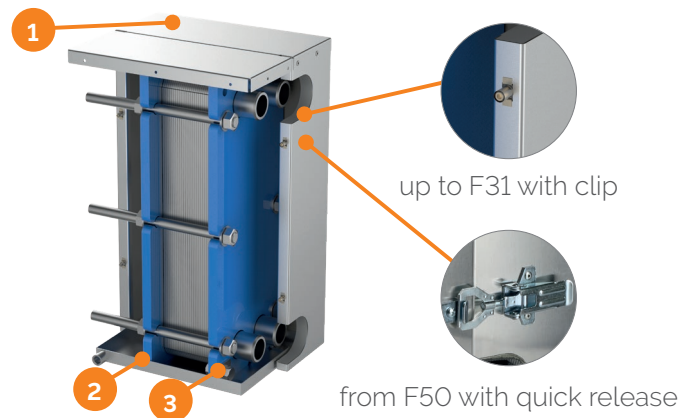

Model	Plates threshold	Aluminium insulation box		Condensate collection tub (mandatory T<15°C)		Feet set	
		Code	Price	Code	Price	Code	Price
K042	up to 38 plates	821080037X		829090894X		821070049X	
	up to 64 plates	821080077X		829091409X			
K080	up to 39 plates	821080085X		829091546X		821070051X	
	up to 64 plates	821080091X		829093407X			
H1	up to 38 plates	821080037X		829090894X		821070049X	
	up to 64 plates	821080077X		829091409X			
H2	up to 39 plates	821080085X		829091546X		821070051X	
	up to 64 plates	821080091X		829093407X			
F10	up to 30 plates	821080070X		829092542X		821070031X	
	up to 60 plates	821080080X		829091094X			
	up to 150 plates	821080082X		829090946X			
F16	up to 30 plates	821080063X		829092542X		821070031X	
	up to 60 plates	821080019X		829091094X			
	up to 150 plates	821080027X		829090946X			
F22	up to 30 plates	821080071X		829092542X		821070031X	
	up to 60 plates	821080054X		829091094X			
	up to 150 plates	821080032X		829090946X			
F206	up to 60 plates	821080055X		829091028X		821070032X	
	up to 150 plates	821080059X		829090857X			
F31	up to 60 plates	821080029X		829091028X		821070032X	
	up to 150 plates	821080017X		829090857X			
F50	up to 60 plates	821080024X		829091028X		821070032X	
	up to 150 plates	821080021X		829090857X			
F71	up to 60 plates	821080096X		829091028X		821070032X	
	up to 150 plates	821080072X		829090857X			

Tables for fast selection - GASKETED INSTANTANEOUS DHW with LOW temperature source

Project conditions

Circuit	Source - endpoint	T _{IN}	T _{OUT}	P _{MAX}	Fluid
HOT side	Heat pump / Condensing water heater	50°C	30°C	10 bar	H ₂ O
COLD side	Domestic Hot Water	10°C	45°C	10 bar	H ₂ O

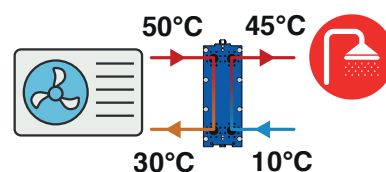

Power kW	Hot side		Cold		Model*	Plates number*	Code	Price	Packaging	
	L/h	kPa	L/h	kPa					Dimensions cm	Weight kg
20	871	4	494	1	K080	9	821K080AHNN009		77x27x42	78
25	1088	4	618	1	K080	11	821K080AHNN011		77x27x42	79
30	1306	4	741	1	K080	13	821K080AHNN013		77x27x42	80
35	1524	4	865	1	K080	15	821K080AHNN015		77x27x54	82
40	1714	5	988	2	K080	15	821K080AHNN015		77x27x54	82
50	2177	5	1235	2	K080	19	821K080AHNN019		77x27x54	84
60	2612	6	1482	2	K080	21	821K080AHNN021		77x27x54	85
75	3265	7	1853	2	K080	25	821K080AHNN025		77x27x54	88
85	3700	6	2100	2	K080	29	821K080AHNN029		77x27x54	90
100	4353	7	2471	2	K080	33	821K080AHNN033		77x27x54	93
120	5224	32	2965	10	F16	15	821F016AN015-1HH07XX00N		97x33x75	134
150	6530	30	3706	9	F16	19	821F016AN019-1HH09XX00N		97x33x75	137
180	7836	36	4447	11	F16	21	821F016AN021-1HH10XX00N		97x33x75	139
210	9142	34	5189	11	F16	25	821F016AN025-1HH12XX00N		97x33x75	142
240	10448	33	5930	10	F16	29	821F016AN029-1HH14XX00N		97x33x75	145
270	11754	32	6671	10	F16	33	821F016AN033-1HH16XX00N		97x33x75	152
300	13060	35	7412	11	F16	35	821F016AN035-1HH17XX00N		97x33x75	153

*Accessories see pag. 37 (See Model and plates number)

Alternative solution with brazed heat exchangers: see pag. 50

Tables for fast selection - GASKETED

INSTANTANEOUS DHW with HIGH temperature source

Project conditions

Circuit	Source - endpoint	T _{IN}	T _{OUT}	P _{MAX}	Fluid
HOT side	Conventional water heater	70°C	50°C	10 bar	H ₂ O
COLD side	Domestic Hot Water	15°C	50°C	10 bar	H ₂ O

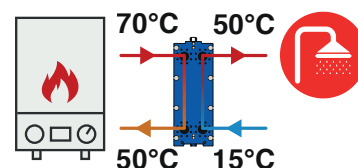

Power kW	Hot side		Cold		Model*	Plates number*	Code	Price	Packaging	
	L/h	kPa	L/h	kPa					Dimensions cm	Weight kg
20	879	10	495	3	K042	7	821K042AHNN007		50x25x35	31
25	1099	9	619	3	K042	9	821K042AHNN009		50x25x35	32
30	1319	13	743	4	K042	9	821K042AHNN009		50x25x35	32
35	1539	17	867	6	K042	9	821K042AHNN009		50x25x35	32
40	1759	14	991	5	K042	11	821K042AHNN011		50x25x35	33
50	2199	15	1236	5	K042	13	821K042AHNN013		50x25x35	33
60	2638	22	1486	8	K042	13	821K042AHNN013		50x25x35	33
75	3298	25	1858	9	K042	15	821K042AHNN015		50x25x45	34
85	3737	25	2106	9	K042	17	821K042AHNN017		50x25x45	34
100	4397	23	2477	8	K042	21	821K042AHNN021		50x25x45	36
120	5276	32	2973	11	K042	21	821K042AHNN021		50x25x45	36
150	6596	36	3716	13	K042	25	821K042AHNN025		50x25x45	37
180	7915	35	4459	12	K042	31	821K042AHNN031		50x25x45	39
210	9234	34	5202	12	K042	37	821K042AHNN037		50x25x45	41
240	10533	32	5945	11	F 10	17	821F010AN017-1HH03HL05N		77x33x47	106
270	11872	35	6688	12	F 10	19	821F010AN019-1HH04HL05N		77x33x47	107
300	13191	34	7431	12	F 10	21	821F010AN021-1HH04HL06N		77x33x47	108

*Accessories see pag. 37 (See Model and plates number)

Alternative solution with brazed heat exchangers: see pag. 51

Tables for fast selection - GASKETED

DHW with STORAGE TANK and HIGH temperature source

Project conditions 1

Circuit	Source - endpoint	T _{IN}	T _{OUT}	P _{MAX}	Fluid
HOT side	Water heater	70°C	50°C	10 bar	H ₂ O
COLD side	Domestic Hot Water	30°C	50°C	10 bar	H ₂ O

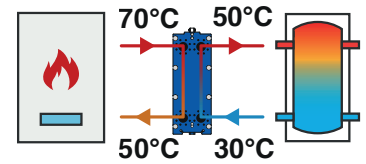

Power kW	Hot side		Cold		Model*	Plates number*	Code	Price	Packaging	
	L/h	kPa	L/h	kPa					Dimensions cm	Weight kg
20	878	6	871	6	K042	9	821K042AHNN009		50x25x35	32
25	1098	9	1087	9	K042	9	821K042AHNN009		50x25x35	32
30	1318	13	1307	13	K042	9	821K042AHNN009		50x25x35	32
35	1537	17	1523	17	K042	9	821K042AHNN009		50x25x35	32
40	1760	22	1742	22	K042	9	821K042AHNN009		50x25x35	32
50	2200	22	2174	22	K042	11	821K042AHNN011		50x25x35	33
60	2640	22	2610	22	K042	13	821K042AHNN013		50x25x35	33
75	3298	25	3265	26	K042	15	821K042AHNN015		50x25x45	34
85	3737	25	3697	26	K042	17	821K042AHNN017		50x25x45	34
100	4396	28	4352	28	K042	19	821K042AHNN019		50x25x45	35
120	5278	27	5223	28	K042	23	821K042AHNN023		50x25x45	36
150	6595	27	6527	28	K042	29	821K042AHNN029		50x25x45	38
180	7916	28	7834	28	K042	35	821K042AHNN035		50x25x45	40
210	9234	28	9140	28	F 10	17	821F010AN017-1HH04HLO4N		77x33x47	106
240	10055	27	10044	27	F 10	21	821F010AN021-1HH06HLO4N		77x33x47	108
270	11930	27	11808	27	F 10	21	821F010AN021-1HH06HLO4N		77x33x47	108
300	13190	30	13053	29	F 10	25	821F010AN025-1HH07HLO5N		77x33x47	111

*Accessories see pag. 37 (See Model and plates number)

Alternative solution with brazed heat exchangers: see pag. 52

Tables for fast selection - GASKETED

DHW with STORAGE TANK and HIGH temperature source

Project conditions 2

Circuit	Source - endpoint	T _{IN}	T _{OUT}	P _{MAX}	Fluid
HOT side	Water heater	80°C	60°C	10 bar	H ₂ O
COLD side	Domestic Hot Water	40°C	60°C	10 bar	H ₂ O

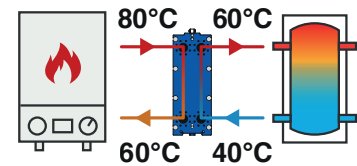

Power kW	Hot side		Cold		Model*	Plates number*	Code	Price	Packaging	
	L/h	kPa	L/h	kPa					Dimensions cm	Weight kg
20	882	6	864	6	K042	9	821K042AHNN009		50x25x35	32
25	1105	9	1094	9	K042	9	821K042AHNN009		50x25x35	32
30	1324	12	1310	13	K042	9	821K042AHNN009		50x25x35	32
35	1548	17	1530	17	K042	9	821K042AHNN009		50x25x35	32
40	1767	22	1749	22	K042	9	821K042AHNN009		50x25x35	32
50	2210	22	2185	22	K042	11	821K042AHNN011		50x25x35	33
60	2649	22	26244	22	K042	13	821K042AHNN013		50x25x35	33
75	3312	25	3279	25	K042	15	821K042AHNN015		50x25x45	34
85	3754	25	3718	25	K042	17	821K042AHNN017		50x25x45	34
100	4597	27	4374	28	K042	19	821K042AHNN019		50x25x45	35
120	5302	27	5248	27	K042	23	821K042AHNN023		50x25x45	36
150	6627	28	6559	28	K042	29	821K042AHNN029		50x25x45	38
180	7952	28	7873	28	K042	35	821K042AHNN035		50x25x45	40
210	9277	19	9184	20	K080	23	821K080AVNN023		77x27x54	87
240	10605	27	10497	27	F 10	19	821F010AN019-1HH04HL05N		77x33x47	107
270	11930	27	11808	27	F 10	21	821F010AN021-1HH04HL06N		77x33x47	108
300	13255	30	13122	29	F 10	23	821F010AN023-1HH05HL06N		77x33x47	109

*Accessories see pag. 37 (See Model and plates number)

Alternative solution with brazed heat exchangers: see pag. 53

Tables for fast selection - GASKETED

HEATING with HIGH temperature endpoints

Project conditions 1

Circuit	Source - endpoint	T _{IN}	T _{OUT}	P _{MAX}	Fluid
HOT side	Conventional water heater	80°C	60°C	10 bar	H ₂ O
COLD side	Radiators	55°C	70°C	10 bar	H ₂ O

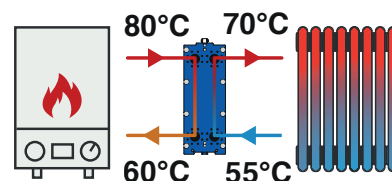

Power kW	Hot side		Cold		Model*	Plates number*	Code	Price	Packaging	
	L/h	kPa	L/h	kPa					Dimensions cm	Weight kg
15	663	1	880	1	K042	19	821K042AHNN019		50x25x45	35
25	1104	4	1467	7	K080	11	821K080AHNN011		77x27x42	79
35	1546	5	2054	9	K080	13	821K080AHNN013		77x27x42	80
50	2209	6	2934	11	K080	17	821K080AHNN017		77x27x54	83
75	3314	8	4401	8	K080	23	821K080AHNN023		77x27x54	87
100	4418	8	5868	15	K080	29	821K080AHNN029		77x27x54	90
115	5081	9	6748	15	K080	33	821K080AHNN033		77x27x54	93
130	5744	9	7628	16	K080	37	821K080AHNN037		77x27x54	95
150	6628	10	8802	17	K080	41	821K080AHNN041		77x27x64	98
180	7953	11	10562	20	F16	27	821F016AN027-1HH06HLO7N		97x33x75	144
200	8837	11	11736	19	F16	31	821F016AN031-1HH07HLO8N		97x33x75	150

*Accessories see pag. 37 (See Model and plates number)

Project conditions 2

Circuit	Source - endpoint	T _{IN}	T _{OUT}	P _{MAX}	Fluid
HOT side	Conventional water heater	75°C	55°C	10 bar	H ₂ O
COLD side	Radiators	50°C	65°C	10 bar	H ₂ O

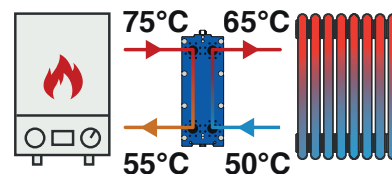

Power kW	Hot side		Cold		Model*	Plates number*	Code	Price	Packaging	
	L/h	kPa	L/h	kPa					Dimensions cm	Weight kg
15	661	4	878	7	K80	7	821K080AHNN007		77x27x42	76
25	1102	4	1463	7	K80	11	821K080AHNN011		77x27x42	79
35	1542	5	2049	10	K80	13	821K080AHNN013		77x27x42	80
50	2203	6	2927	11	K80	17	821K080AHNN017		77x27x54	83
75	3305	8	4390	13	K80	23	821K080AHNN023		77x27x54	87
100	4407	9	5853	15	K80	29	821K080AHNN029		77x27x54	90
115	5068	9	6732	15	K80	33	821K080AHNN033		77x27x54	93
130	5730	9	7609	16	K80	37	821K080AHNN037		77x27x54	95
150	6612	9	8780	16	K80	43	821K080AHNN043		77x27x64	99
180	7934	12	10536	20	F16	27	821F016AN027-1HH10LL03N		97x33x75	144
200	8815	11	11706	19	F16	31	821F016AN031-1HH07HLO8N		97x33x75	150

*Accessories see pag. 37 (See Model and plates number)

Alternative solution with brazed heat exchangers: see pag. 54

Tables for fast selection - GASKETED

HEATING with HIGH temperature endpoints

Project conditions 3

Circuit	Source - endpoint	T _{IN}	T _{OUT}	P _{MAX}	Fluid
HOT side	Condensing water heater	70°C	50°C	10 bar	H ₂ O
COLD side	Radiators / Fan Coil	45°C	60°C	10 bar	H ₂ O

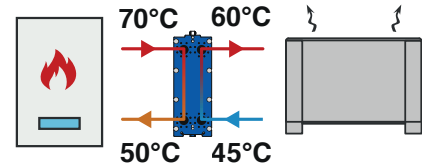

Power kW	Hot side		Cold		Model*	Plates number*	Code	Price	Packaging	
	L/h	kPa	L/h	kPa					Dimensions cm	Weight kg
15	660	1	876	1	K042	21	821K042AHNN021		50x25x45	36
25	1099	4	1460	7	K080	11	821K080AHNN011		77x27x42	79
35	1539	5	2044	10	K080	13	821K080AHNN013		77x27x42	80
50	2199	6	2920	11	K080	17	821K080AHNN017		77x27x54	83
75	3298	6	4379	11	K080	25	821K080AHNN025		77x27x54	88
100	4397	8	5839	13	K080	31	821K080AHNN031		77x27x54	92
115	5057	8	6715	14	K080	35	821K080AHNN035		77x27x54	94
130	5716	8	7591	15	K080	39	821K080AHNN039		77x27x64	97
150	6596	9	8759	15	K080	45	821K080AHNN045		77x27x64	101
180	7915	9	10510	16	K080	53	821K080AHNN053		77x27x64	106
200	8794	10	11678	17	K080	59	821K080AHNN059		77x27x64	109

*Accessories see pag. 37 (See Model and plates number)

Project conditions 4

Circuit	Source - endpoint	T _{IN}	T _{OUT}	P _{MAX}	Fluid
HOT side	Condensing water heater	70°C	60°C	10 bar	H ₂ O
COLD side	Radiators / Fan Coil	50°C	60°C	10 bar	H ₂ O

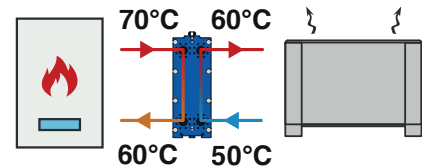

Power kW	Hot side		Cold		Model*	Plates number*	Code	Price	Packaging	
	L/h	kPa	L/h	kPa					Dimensions cm	Weight kg
15	1322	12	1315	13	K042	9	821K042AHNN009		50x25x35	32
25	2203	15	2192	16	K042	13	821K042AHNN013		50x25x35	33
35	3085	17	3069	17	K042	17	821K042AHNN017		50x25x45	34
50	4408	19	4385	19	K042	23	821K042AHNN023		50x25x45	36
75	6612	18	6577	18	K080	17	821K080AHNN017		77x27x54	83
100	8816	17	8769	18	K080	23	821K080AHNN023		77x27x54	87
115	10138	19	10085	20	K080	25	821K080AHNN025		77x27x54	88
130	11460	19	11400	19	K080	29	821K080AHNN029		77x27x54	90
150	13223	19	13154	19	F10	27	821F010AN027-1HH04HL09N		77x33x47	112
180	15868	20	15785	20	F10	31	821F010AN031-1HH03HL12N		77x33x71	118
200	17631	19	17539	19	F10	35	821F010AN035-1HH03HL14N		77x33x71	120

*Accessories see pag. 37 (See Model and plates number)

Alternative solution with brazed heat exchangers: see pag. 55

Tables for fast selection - GASKETED

HEATING with LOW temperature endpoints

Project conditions 1

Circuit	Source - endpoint	T _{IN}	T _{OUT}	P _{MAX}	Fluid
HOT side	Heat Pump high temp. / Conventional WH	60°C	40°C	10 bar	H ₂ O
COLD side	Radiating floor / Fan Coil	30°C	40°C	10 bar	H ₂ O

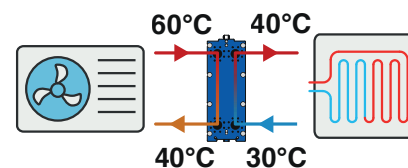

Power kW	Hot side		Cold		Model*	Plates number*	Code	Price	Packaging	
	L/h	kPa	L/h	kPa					Dimensions cm	Weight kg
15	656	3	1302	13	K042	9	821K042AHNN009		50x25x35	32
25	1093	4	2170	16	K042	13	821K042AHNN013		50x25x35	33
35	1531	5	3038	18	K042	17	821K042AHNN017		50x25x45	35
50	2187	5	4340	20	K042	23	821K042AHNN023		50x25x45	36
75	3281	6	6511	20	K080	17	821K080AHNN017		77x27x54	83
100	4375	5	8681	19	K080	23	821K080AHNN023		77x27x54	87
115	5032	5	9983	18	F10	19	821F010AN019-1HH05LLO4N		77x33x47	107
130	5687	5	11285	18	F10	21	821F010AN021-1HH05LLO5N		77x33x47	108
150	6563	6	13022	19	F10	25	821F010AN025-1HH07LLO5N		77x33x47	111
180	7876	6	15626	19	F10	29	821F010AN029-1HH07LLO7N		77x33x47	113
200	8751	6	17362	19	F10	33	821F010AN033-1HH08LLO8N		77x33x71	119

*Accessories see pag. 37 (See Model and plates number)

Project conditions 2

Circuit	Source - endpoint	T _{IN}	T _{OUT}	P _{MAX}	Fluid
HOT side	Heat Pump high temp.	55°C	35°C	10 bar	H ₂ O
COLD side	Radiating floor	25°C	35°C	10 bar	H ₂ O

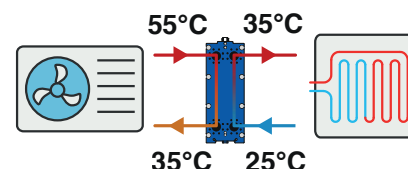

Power kW	Hot side		Cold		Model*	Plates number*	Code	Price	Packaging	
	L/h	kPa	L/h	kPa					Dimensions cm	Weight kg
15	655	3	1299	13	K042	9	821K042AHNN009		50x25x35	32
25	1092	4	2165	16	K042	13	821K042AHNN013		50x25x35	33
35	1528	5	3031	18	K042	17	821K042AHNN017		50x25x45	35
50	2182	5	4329	20	K042	23	821K042AHNN023		50x25x45	36
75	3273	5	6494	17	K080	19	821K080AHNN019		77x27x54	84
100	4364	5	8659	20	K080	23	821K080AHNN023		77x27x54	87
115	5019	6	9958	18	F10	19	821F010AN019-1HH05LLO4N		77x33x47	107
130	5674	5	11257	20	F10	23	821F010AN023-1HH03HLO8N		77x33x47	109
150	6547	6	12988	20	F10	25	821F010AN025-1HH07LLO5N		77x33x47	111
180	7856	6	15586	19	F10	29	821F010AN029-1HH07LLO7N		77x33x47	113
200	8729	6	17318	19	F10	33	821F010AN033-1HH08LLO8N		77x33x71	119

*Accessories see pag. 37 (See Model and plates number)

Alternative solution with brazed heat exchangers: see pag. 56

Tables for fast selection - GASKETED HEATING for CHLORINATED pool

Project conditions

Circuit	Source - endpoint	T _{IN}	T _{OUT}	P _{MAX}	Fluid
HOT side	Water heater	70°C	50°C	10 bar	H ₂ O
COLD side	Piscina Acqua Clorata	25°C	40°C	10 bar	H ₂ O+Cl

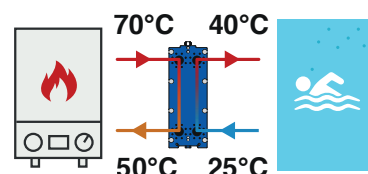

Power kW	Hot side		Cold		Model*	Plates number*	Code	Price	Packaging	
	L/h	kPa	L/h	kPa					Dimensions cm	Weight kg
20	880	4	1156	7	K042	11	821K042AHNN011		50x25x35	33
25	1099	6	1445	10	K042	11	821K042AHNN011		50x25x35	33
35	1539	8	2023	14	K042	13	821K042AHNN013		50x25x35	33
50	2199	8	2890	13	K042	19	821K042AHNN019		50x25x45	35
75	3298	7	4335	12	K080	15	821K080AVNN015		77x27x54	82
100	4397	7	5780	14	K080	19	821K080AVNN019		77x27x54	84
115	5057	8	6647	14	F10	11	821F010AN011-1LL05XX00N		77x33x47	102
130	5716	9	7514	14	F10	13	821F010AN013-1HL03LL03N		77x33x47	103
150	6596	9	8670	14	F10	15	821F010AN015-1HL03LL04N		77x33x47	104
180	7915	8	10404	14	F10	17	821F010AN017-1LL08XX00N		77x33x47	106
200	8794	9	11560	15	F10	19	821F010AN019-1HL03LL06N		77x33x47	107

*Accessories see pag. 37 (See Model and plates number)

HEATING for SEA WATER pool (Titanium plates)

Project conditions

Circuit	Source - endpoint	T _{IN}	T _{OUT}	P _{MAX}	Fluid
HOT side	Water heater	70°C	50°C	10 bar	H ₂ O
COLD side	Piscina Acqua Salata	25°C	40°C	10 bar	H ₂ O+NaCl

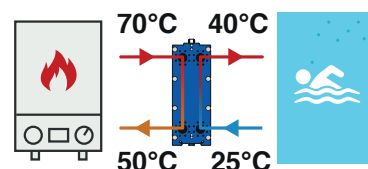

Power kW	Hot side		Cold		Model*	Plates number*	Code	Price	Packaging	
	L/h	kPa	L/h	kPa					Dimensions cm	Weight kg
20	879	6	1156	10	K042	9	821K042CHNP009		50x25x35	31
25	1099	6	1445	10	K042	11	821K042CHNP011		50x25x35	31
35	1539	8	2023	14	K080	7	821K080CVNP007		77x27x42	74
50	2198	6	2890	11	K080	11	821K080CVNP011		77x27x42	76
75	3297	7	4335	12	K080	15	821K080CVNP015		77x27x54	77
100	4396	6	5780	10	F10	11	821F010CN011-1LL05XX00N		77x33x47	100
115	5055	8	6647	13	F10	11	821F010CN011-1LL05XX00N		77x33x47	100
130	5714	9	7514	14	F10	13	821F010CN013-1HL03LL03N		77x33x47	100
150	6593	9	8670	14	F10	15	821F010CN015-1HL03LL04N		77x33x47	101
180	7912	8	10404	14	F10	17	821F010CN017-1LL08XX00N		77x33x47	102
200	8791	9	11560	15	F10	19	821F010CN019-1HL03LL06N		77x33x47	103

*Accessories see pag. 37 (See Model and plates number)

Tables for fast selection - GASKETED HEATING with Thermal Solar

Project conditions

Circuit	Source - endpoint	T _{IN}	T _{OUT}	P _{MAX}	Fluid
HOT side	Solar panel	60°C	50°C	10 bar	Glic. 30%
COLD side	Heating / Domestic Hot Water	40°C	50°C	10 bar	H ₂ O

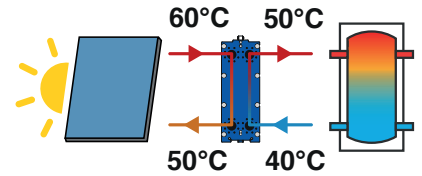

Power kW	Hot side		Cold		Model*	Plates number*	Code	Price	Packaging	
	L/h	kPa	L/h	kPa					Dimensions cm	Weight kg
20	1839	12	1745	10	K042	13	821K042AHEN013		50x25x35	33
35	3218	14	3054	12	K042	21	821K042AHEN021		50x25x45	36
50	4598	10	4363	8	K080	19	821K080AVEN019		77x27x54	84
75	6897	11	6544	9	K080	27	821K080AVEN027		77x27x54	89
100	9196	14	8726	11	F10	25	821F010AE025-1HH05HL07N		77x33x47	111
*Accessories see pag. 37 (See Model and plates number)										

The solar thermal makes it roughly 0.8 kW/m².
 Example 10 Fiorini collectors H2500 (pag. 254) is equal to 25m²= 20kW

Alternative solution with brazed heat exchangers: see pag. 57

Brazed heat exchangers P and WP series

The brazed plate heat exchangers (P and WP series) are used in heating, cooling and heat recuperation systems. The quality of the parts and the brazing process, which is carried out with care, make a trustworthy product. The plate design makes it possible to reach higher heat exchange performances and lower pressure loss. Moreover, the product has an elevated resistance to high temperatures and pressure.

Our brazed plate heat exchangers can be used with many kinds of fluids in various combinations (ex: water/water, water/oil, water/steam, steam/oil, Freon/water, etc.)

Advantages

- compact design
- reasonable weight
- high heat exchange efficiency
- high temperature range (-160/+ 195 °C)
- high max operating pressure (30 bar)

Main applications

- heating/cooling of technical water or industrial fluids
- evaporation and condensation of refrigerant gas
- hydraulic separation of the circuit
- heat recuperation in domestic applications and industrial processes
- functioning with a wide range of compatible fluids
- mechanical and chemical resistance of the materials



Brazed heat exchanger Range



Model	WP4	P4	P7	P15	P30
Plate surface (m ²)	0,03	0,02375	0,07	0,15	0,30
Nominal pressure	PN16	PN30	PN30	PN30	PN30
Standard coupling	1"	1"	1 1/4"	2"	2 1/2"
PP (mm)	13+2,3xN*	9+2,4xN*	9+2,57xN*	10+2,48xN*	11+2,90xN*
A (mm)	335	310	526	530	782
B (mm)	124	111	120	256	350
C (mm)	281	250	473	439	655
D (mm)	73	50	66	177	220
PC (mm)	20	24	27	27	27

*Plate No.

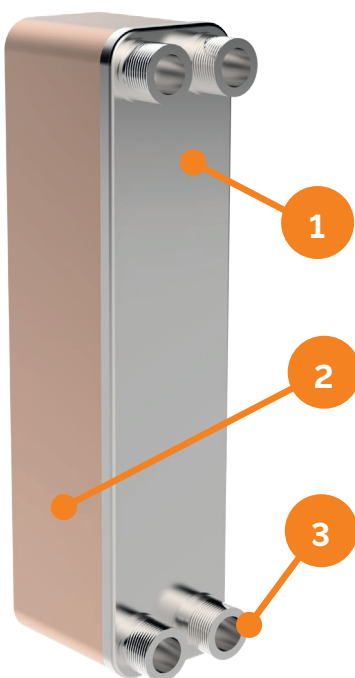

Legend

1. Front plate
2. Brazing
3. Coupling

Couplings

- Primary: Inlet F1
 Primary: Outlet F4
 Secondary: Inlet F3
 Secondary: Outlet F2

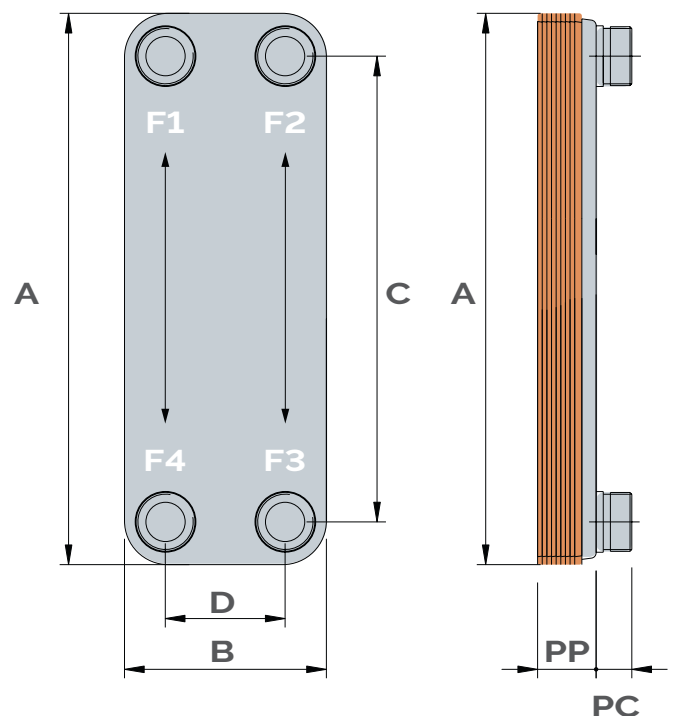

Accessories

Insulation, Couplings

WP4, P4, P7 Serie: PE insulation thermoformed removable with velcro strips.

Model	Plates threshold	Code	Price
WP4	up to 14 plates	843090066X	
	up to 20 plates	843090067X	
	up to 30 plates	843090068X	
	up to 40 plates	843090069X	
	up to 50 plates	843090070X	
P4	up to 14 plates	843090016X	
	up to 20 plates	843090017X	
	up to 30 plates	843090018X	
	up to 40 plates	843090019X	
	up to 50 plates	843090020X	
	up to 60 plates	843090060X	
P7	up to 30 plates	843090050X	
	up to 50 plates	843090051X	
	up to 70 plates	843090052X	

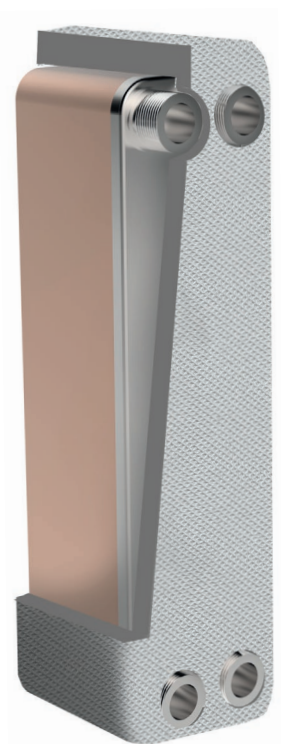
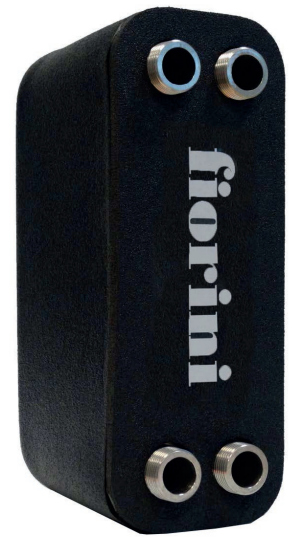

Serie P15 / P30: insulation kit made of sheets of pre-cut adhesive elastomer, finishing tape and assembly instructions.

Model	Plates threshold	Code	Price
P15	from 30 up to 80 plates	843090053X	
	from 81 up to 140 plates	843090054X	
	from 141 up to 200 plates	843090055X	
P30	from 30 up to 80 plates	843090056X	
	from 81 up to 140 plates	843090057X	

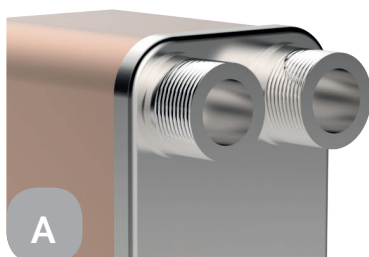

A
threaded standard

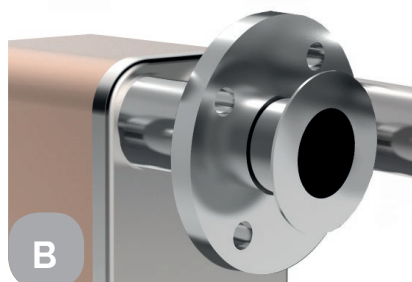

B
free flange upon request

All brazed heat exchangers comes with threaded couplings. Upon request, additional couplings and free flange couplings.

Tables for fast selection - BRAZED

INSTANTANEOUS DHW with LOW temperature source

Project conditions

Circuit	Source - endpoint	T _{IN}	T _{OUT}	P _{MAX}	Fluid
HOT side	Heat pump / Condensing water heater	50°C	30°C	16 bar (WP4) 30 bar (P4-P7-P15-P30)	H ₂ O
COLD side	Domestic Hot Water	10°C	45°C	16 bar (WP4) 30 bar (P4-P7-P15-P30)	H ₂ O

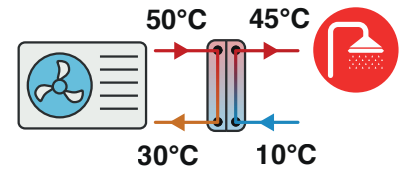

Power kW	Hot side		Cold		Model*	Plates number*	Code	Price	Packaging	
	L/h	kPa	L/h	kPa					Dimensions cm	Weight kg
20	868	1	494	0	WP4	20	821021102X		43x22x24	4
25	1085	2	617	1	WP4	20	821021102X		43x22x24	4
30	1302	1	740	0	WP4	30	821021103X		43x22x24	5
35	1519	2	864	1	WP4	30	821021103X		43x22x24	5
40	1736	1	988	0	WP4	40	821021104X		43x22x24	6
50	2170	2	1235	1	WP4	40	821021104X		43x22x24	6
60	2604	2	1482	1	WP4	50	821021105X		43x22x24	8
75	3260	23	1850	7	P7	30	821020852X		60x80x26	11
85	3690	29	2100	9	P7	30	821020852X		60x80x26	11
100	4340	15	2470	5	P7	50	821020856X		60x80x31	15
120	5210	21	2960	7	P7	50	821020856X		60x80x31	15
150	6510	31	3700	11	P7	50	821020856X		60x80x31	15
180	7810	24	4440	8	P7	70	821020858X		60x80x37	19
210	9120	32	5190	11	P7	70	821020858X		60x80x37	19
240	10420	27	5930	10	P15	40	821020865X		60x80x29	28
270	11720	33	6670	12	P15	40	821020865X		60x80x29	28
300	13020	27	7410	10	P15	50	821020866X		60x80x31	32

*Accessories see
pag. 49 (See Model
and plates number)

Alternative solution with gasketed heat exchangers: see pag. 38

Tables for fast selection - BRAZED

INSTANTANEOUS DHW with HIGH temperature source

Project conditions

Circuit	Source - endpoint	T _{IN}	T _{OUT}	P _{MAX}	Fluid
HOT side	Conventional water heater	70°C	50°C	16 bar (WP4) 30 bar (P4-P7-P15-P30)	H ₂ O
COLD side	Domestic Hot Water	15°C	50°C	16 bar (WP4) 30 bar (P4-P7-P15-P30)	H ₂ O

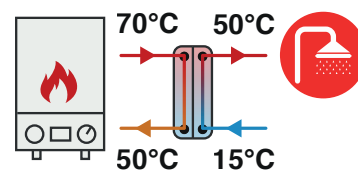

Power kW	Hot side		Cold		Model*	Plates number*	Code	Price	Packaging	
	L/h	kPa	L/h	kPa					Dimensions cm	Weight kg
20	875	3	495	1	WP4	14	821021101X		43x22x24	3
25	1094	2	618	1	WP4	20	821021102X		43x22x24	4
30	1312	1	742	0	WP4	30	821021103X		43x22x24	5
35	1531	2	866	1	WP4	30	821021103X		43x22x24	5
40	1750	1	990	0	WP4	40	821021104X		43x22x24	6
50	2187	2	1237	1	WP4	40	821021104X		43x22x24	6
60	2625	2	1484	1	WP4	50	821021105X		43x22x24	8
75	3280	22	1860	7	P7	30	821020852X		60x80x26	11
85	3720	27	2100	9	P7	30	821020852X		60x80x26	11
100	4370	36	2470	12	P7	30	821020852X		60x80x26	11
120	5250	20	2970	7	P7	50	821020856X		60x80x31	15
150	6560	30	3710	10	P7	50	821020856X		60x80x31	15
180	7870	23	4450	8	P7	70	821020858X		60x80x37	19
210	9190	31	5190	11	P7	70	821020858X		60x80x37	19
240	10500	25	5940	9	P15	40	821020865X		60x80x29	28
270	11810	31	6680	12	P15	40	821020865X		60x80x29	28
300	13120	25	7420	10	P15	50	821020866X		60x80x31	32

*Accessories see
pag. 49 (See Model
and plates number)

Alternative solution with gasketed heat exchangers: see pag. 39

Tables for fast selection - BRAZED

DHW with STORAGE TANK and HIGH temperature source

Project conditions 1

Circuit	Source - endpoint	T _{IN}	T _{OUT}	P _{MAX}	Fluid
HOT side	Water heater	70°C	50°C	16 bar (WP4) 30 bar (P4-P7-P15-P30)	H ₂ O
COLD side	Domestic Hot Water	30°C	50°C	16 bar (WP4) 30 bar (P4-P7-P15-P30)	H ₂ O

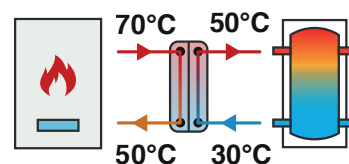

Power kW	Hot side		Cold		Model*	Plates number*	Code	Price	Packaging	
	L/h	kPa	L/h	kPa					Dimensions cm	Weight kg
20	875	3	868	2	WP4	14	821021101X		43x22x24	3
25	1094	6	1085	4	WP4	14	821021101X		43x22x24	3
30	1312	9	1302	6	WP4	14	821021101X		43x22x24	3
35	1531	5	1519	4	WP4	20	821021102X		43x22x24	4
40	1750	7	1736	5	WP4	20	821021102X		43x22x24	4
50	2187	13	2170	9	WP4	20	821021102X		43x22x24	4
60	2625	20	2604	15	WP4	20	821021102X		43x22x24	4
75	3281	12	3256	10	WP4	30	821021103X		43x22x24	5
85	3719	16	3690	14	WP4	30	821021103X		43x22x24	5
100	4375	12	4341	10	WP4	40	821021104X		43x22x24	6
120	5250	19	5209	17	WP4	40	821021104X		43x22x24	6
150	6560	30	6510	28	P7	50	821020856X		60x80x31	15
180	7870	23	7810	23	P7	70	821020858X		60x80x37	19
210	9190	31	9120	30	P7	70	821020858X		60x80x37	19
240	10500	25	10420	25	P15	40	821020865X		60x80x29	28
270	11810	31	11720	32	P15	40	821020865X		60x80x29	28
300	13120	25	13020	26	P15	50	821020866X		60x80x31	32

*Accessories see pag. 49 (See Model and plates number)

Alternative solution with gasketed heat exchangers: see pag. 40

Tables for fast selection - BRAZED

DHW with STORAGE TANK and HIGH temperature source

Project conditions 2

Circuit	Source - endpoint	T _{IN}	T _{OUT}	P _{MAX}	Fluid
HOT side	Water heater	80°C	60°C	16 bar (WP4) 30 bar (P4-P7-P15-P30)	H ₂ O
COLD side	Domestic Hot Water	40°C	60°C	16 bar (WP4) 30 bar (P4-P7-P15-P30)	H ₂ O

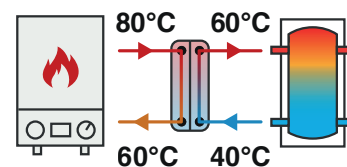

Power kW	Hot side		Cold		Model*	Plates number*	Code	Price	Packaging	
	L/h	kPa	L/h	kPa					Dimensions cm	Weight kg
20	879	3	871	2	WP4	14	821021101X		43x22x24	3
25	1098	6	1089	4	WP4	14	821021101X		43x22x24	3
30	1318	9	1308	6	WP4	14	821021101X		43x22x24	3
35	1538	14	1525	9	WP4	14	821021101X		43x22x24	3
40	1758	7	1743	5	WP4	20	821021102X		43x22x24	4
50	2197	12	2179	9	WP4	20	821021102X		43x22x24	4
60	2636	20	2614	15	WP4	20	821021102X		43x22x24	4
75	3295	12	3268	10	WP4	30	821021103X		43x22x24	5
85	3735	16	3704	13	WP4	30	821021103X		43x22x24	5
100	4394	25	4357	20	WP4	30	821021103X		43x22x24	5
120	5272	19	5228	16	WP4	40	821021104X		43x22x24	6
150	6590	19	6536	18	WP4	50	821021105X		43x22x24	8
180	7910	23	7840	22	P7	70	821020858X		60x80x37	19
210	9230	30	9150	29	P7	70	821020858X		60x80x37	19
240	10540	25	10460	25	P15	40	821020865X		60x80x29	28
270	11860	31	11760	31	P15	40	821020865X		60x80x29	28
300	13180	25	13070	25	P15	40	821020865X		60x80x29	32

*Accessories see pag. 49 (See Model and plates number)

Alternative solution with gasketed heat exchangers: see pag. 41

Tables for fast selection - GASKETED

HEATING with HIGH temperature endpoints

Project conditions 1

Circuit	Source - endpoint	T _{IN}	T _{OUT}	P _{MAX}	Fluid
HOT side	Conventional water heater	80°C	60°C	16 bar (WP4) 30 bar (P4-P7-P15-P30)	H ₂ O
COLD side	Radiators	55°C	70°C	16 bar (WP4) 30 bar (P4-P7-P15-P30)	H ₂ O

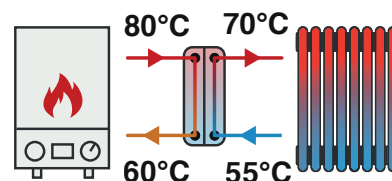

Power kW	Hot side		Cold		Model*	Plates number*	Code	Price	Packaging	
	L/h	kPa	L/h	kPa					Dimensions cm	Weight kg
15	659	2	876	2	WP4	14	821021101X		43x22x24	3
25	1098	6	1460	8	WP4	14	821021101X		43x22x24	3
35	1538	5	2044	8	WP4	20	821021102X		43x22x24	4
50	2197	4	2920	7	WP4	30	821021103X		43x22x24	5
75	3295	5	4379	10	WP4	40	821021104X		43x22x24	6
100	4394	7	5839	13	WP4	50	821021105X		43x22x24	8
115	5050	10	6710	16	P7	70	821020858X		60x80x37	19
130	5710	13	7590	20	P7	70	821020858X		60x80x37	19
150	6590	10	8760	17	P15	40	821020865X		60x80x29	28
180	7910	15	10510	24	P15	40	821020865X		60x80x29	28
200	8790	12	11680	20	P15	50	821020866X		60x80x31	32

*Accessories see pag. 49 (See Model and plates number)

Project conditions 2

Circuit	Source - endpoint	T _{IN}	T _{OUT}	P _{MAX}	Fluid
HOT side	Conventional water heater	75°C	55°C	16 bar (WP4) 30 bar (P4-P7-P15-P30)	H ₂ O
COLD side	Radiators	50°C	65°C	16 bar (WP4) 30 bar (P4-P7-P15-P30)	H ₂ O

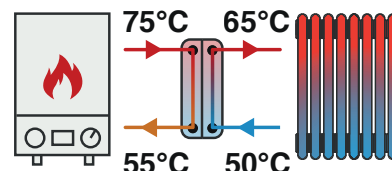

Power kW	Hot side		Cold		Model*	Plates number*	Code	Price	Packaging	
	L/h	kPa	L/h	kPa					Dimensions cm	Weight kg
15	658	2	874	2	WP4	14	821021101X		43x22x24	3
25	1096	6	1457	8	WP4	14	821021101X		43x22x24	3
35	1534	5	2039	8	WP4	20	821021102X		43x22x24	4
50	2192	4	2913	7	WP4	30	821021103X		43x22x24	5
75	3288	6	4370	10	WP4	40	821021104X		43x22x24	6
100	4384	7	5827	13	WP4	50	821021105X		43x22x24	8
115	5040	10	6700	16	P7	70	821020858X		60x80x37	19
130	5700	13	7570	20	P7	70	821020858X		60x80x37	19
150	6580	11	8740	17	P15	40	821020865X		60x80x29	28
180	7890	15	10490	24	P15	40	821020865X		60x80x29	28
200	8770	12	11650	20	P15	50	821020866X		60x80x31	32

*Accessories see pag. 49 (See Model and plates number)

Alternative solution with gasketed heat exchangers: see pag. 42

Tables for fast selection - GASKETED

HEATING with HIGH temperature endpoints

Project conditions 3

Circuit	Source - endpoint	T _{IN}	T _{OUT}	P _{MAX}	Fluid
HOT side	Condensing water heater	70°C	50°C	16 bar (WP4) 30 bar (P4-P7-P15-P30)	H ₂ O
COLD side	Radiators / Fan Coil	45°C	60°C	16 bar (WP4) 30 bar (P4-P7-P15-P30)	H ₂ O

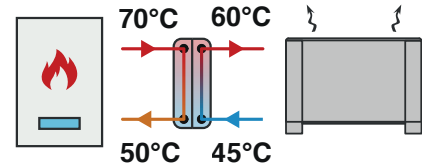

Power kW	Hot side		Cold		Model*	Plates number*	Code	Price	Packaging	
	L/h	kPa	L/h	kPa					Dimensions cm	Weight kg
15	656	2	872	2	WP4	14	821021101X		43x22x24	3
25	1094	6	1454	8	WP4	14	821021101X		43x22x24	3
35	1531	5	2035	8	WP4	20	821021102X		43x22x24	4
50	2187	4	2907,5	7	WP4	30	821021103X		43x22x24	5
75	3281	6	4361	10	WP4	40	821021104X		43x22x24	6
100	4370	14	5820	22	P7	50	821020856X		60x80x31	15
115	5030	10	6690	16	P7	70	821020858X		60x80x37	19
130	5690	13	7560	20	P7	70	821020858X		60x80x37	19
150	6560	10	8720	18	P15	40	821020865X		60x80x29	28
180	7870	10	10470	17	P15	50	821020866X		60x80x31	32
200	8750	12	11630	20	P15	50	821020866X		60x80x31	32

*Accessories see pag. 49 (See Model and plates number)

Project conditions 4

Circuit	Source - endpoint	T _{IN}	T _{OUT}	P _{MAX}	Fluid
HOT side	Condensing water heater	70°C	60°C	16 bar (WP4) 30 bar (P4-P7-P15-P30)	H ₂ O
COLD side	Radiators / Fan Coil	50°C	60°C	16 bar (WP4) 30 bar (P4-P7-P15-P30)	H ₂ O

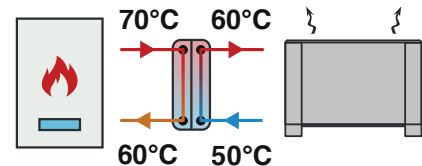

Power kW	Hot side		Cold		Model*	Plates number*	Code	Price	Packaging	
	L/h	kPa	L/h	kPa					Dimensions cm	Weight kg
15	1315	9	1310	6	WP4	14	821021101X		43x22x24	3
25	2192	18	2182	13	WP4	20	821021102X		43x22x24	4
35	3069	10	3056	8	WP4	30	821021103X		43x22x24	5
50	4384	12	4366	10	WP4	40	821021104X		43x22x24	6
75	6580	17	6550	16	P7	70	821020858X		60x80x37	19
100	8770	18	8730	18	P15	40	821020865X		60x80x29	28
115	10080	23	10040	23	P15	40	821020865X		60x80x29	28
130	11400	19	11350	19	P15	50	821020866X		60x80x31	32
150	13150	18	13100	18	P15	60	821020867X		60x80x34	36
180	15780	20	15720	20	P15	70	821020868X		60x80x36	40
200	17540	24	17460	24	P15	70	821020868X		60x80x36	40

*Accessories see pag. 49 (See Model and plates number)

Alternative solution with gasketed heat exchangers: see pag. 43

Tables for fast selection - BRAZED

HEATING with LOW temperature endpoints

Project conditions 1

Circuit	Source - endpoint	T _{IN}	T _{OUT}	P _{MAX}	Fluid
HOT side	Heat Pump high temp. / Conventional WH	60°C	40°C	16 bar (WP4) 30 bar (P4-P7-P15-P30)	H ₂ O
COLD side	Radiating floor / Fan Coil	30°C	40°C	16 bar (WP4) 30 bar (P4-P7-P15-P30)	H ₂ O

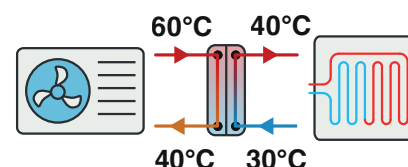

Power kW	Hot side		Cold		Model*	Plates number*	Code	Price	Packaging	
	L/h	kPa	L/h	kPa					Dimensions cm	Weight kg
15	654	2	1300	6	WP4	14	821021101X		43x22x24	3
25	1089	2	2166	10	WP4	20	821021102X		43x22x24	4
35	1525	2	3033	8	WP4	30	821021103X		43x22x24	5
50	2178,5	1	4333	7	WP4	40	821021104X		43x22x24	6
75	3270	5	6500	16	P7	70	821020858X		60x80x37	19
100	4360	5	8670	19	P15	40	821020865X		60x80x29	21,5
115	5010	5	9970	16	P15	50	821020866X		60x80x31	32
130	5660	6	11270	20	P15	50	821020866X		60x80x31	32
150	6540	5	13000	19	P15	60	821020867X		60x80x34	36
180	7540	6	15600	21	P15	70	821020868X		60x80x36	40
200	8710	7	17330	25	P15	70	821020868X		60x80x36	40

*Accessories see pag. 49 (See Model and plates number)

Project conditions 2

Circuit	Source - endpoint	T _{IN}	T _{OUT}	P _{MAX}	Fluid
HOT side	Heat Pump high temp.	55°C	35°C	16 bar (WP4) 30 bar (P4-P7-P15-P30)	H ₂ O
COLD side	Radiating floor	25°C	35°C	16 bar (WP4) 30 bar (P4-P7-P15-P30)	H ₂ O

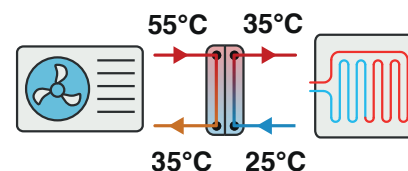

Power kW	Hot side		Cold		Model*	Plates number*	Code	Price	Packaging	
	L/h	kPa	L/h	kPa					Dimensions cm	Weight kg
15	652	2	1298	6	WP4	14	821021101X		43x22x24	3
25	1087	2	2163	10	WP4	20	821021102X		43x22x24	4
35	1522	2	3028	8	WP4	30	821021103X		43x22x24	5
50	2174	2	4325	11	WP4	40	821021104X		43x22x24	6
75	3260	5	6490	17	P7	70	821020858X		60x80x37	19
100	4350	5	8650	19	P15	40	821020865X		60x80x29	28
115	5000	5	9950	17	P15	50	821020866X		60x80x31	32
130	5650	6	11250	21	P15	50	821020866X		60x80x31	32
150	6520	5	12980	20	P15	60	821020867X		60x80x34	36
180	7830	6	15570	21	P15	70	821020868X		60x80x36	40
200	8700	7	17300	26	P15	70	821020868X		60x80x36	40

*Accessories see pag. 49 (See Model and plates number)

Alternative solution with gasketed heat exchangers: see pag. 44

Tables for fast selection - GASKETED HEATING with Thermal Solar

Circuit	Source - endpoint	T _{IN}	T _{OUT}	P _{MAX}	Fluid
HOT side	Solar panel	60°C	50°C	16 bar (WP4) 30 bar (P4-P7-P15-P30)	Glic. 30%
COLD side Heating / Domestic Hot Water		40°C	50°C	16 bar (WP4) 30 bar (P4-P7-P15-P30)	H ₂ O

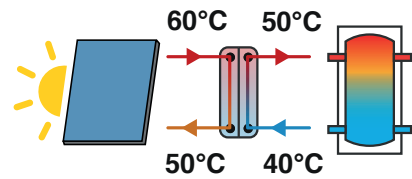

Power kW	Hot side		Cold		Model*	Plates number*	Code	Price	Packaging	
	L/h	kPa	L/h	kPa					Dimensions cm	Weight kg
20	1807	3	1740	2	WP4	30	821021103X		43x22x24	5
35	3162	6	3044	4	WP4	40	821021104X		43x22x24	6
50	4520	10	4350	8	P7	70	821020858X		60x80x37	19
75	6770	13	6520	11	P15	40	821020865X		60x80x29	28
100	9030	15	8700	12	P15	50	821020866X		60x80x31	32

*Accessories see pag. 49 (See Model and plates number)

The solar thermal makes it roughly 0.8 kW/m².
Example 10 Fiorini collectors H2500 (pag. 254) is equal to 25m²= 20kW

Alternative solution with gasketed heat exchangers: see pag. 46

Plant Solutions

Instantaneous DHW (see SET pag. 214)

Legend

1. Fiorini Puffer PFA (see 236)
2. Expansion vessel
3. Dirt separator
4. Sanitary charging pump
5. Fiorini plate heat exchanger
6. Sanitary recirculation pump
7. Thermostatic DHW mixer
8. Bacteriostatic cold water filter

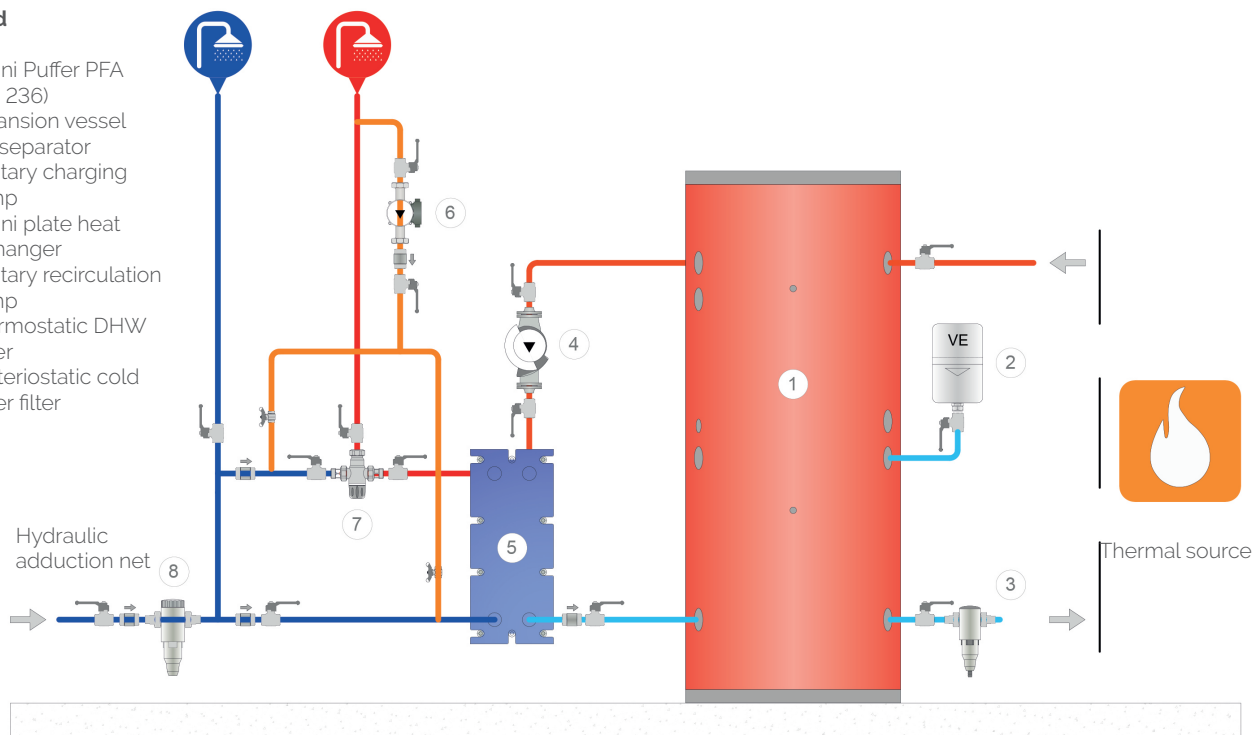

SET fresh water station see pag. 214

DHW with storage tank (see AFK pag. 214)

Legend

1. Fiorini Sanitary storage tank (see 136)
2. Safety unit
3. Fiorini plate heat exchanger
4. Sanitary charging pump
5. Bacteriostatic cold water filter
6. Sanitary recirculation pump
7. Thermostatic DHW mixer

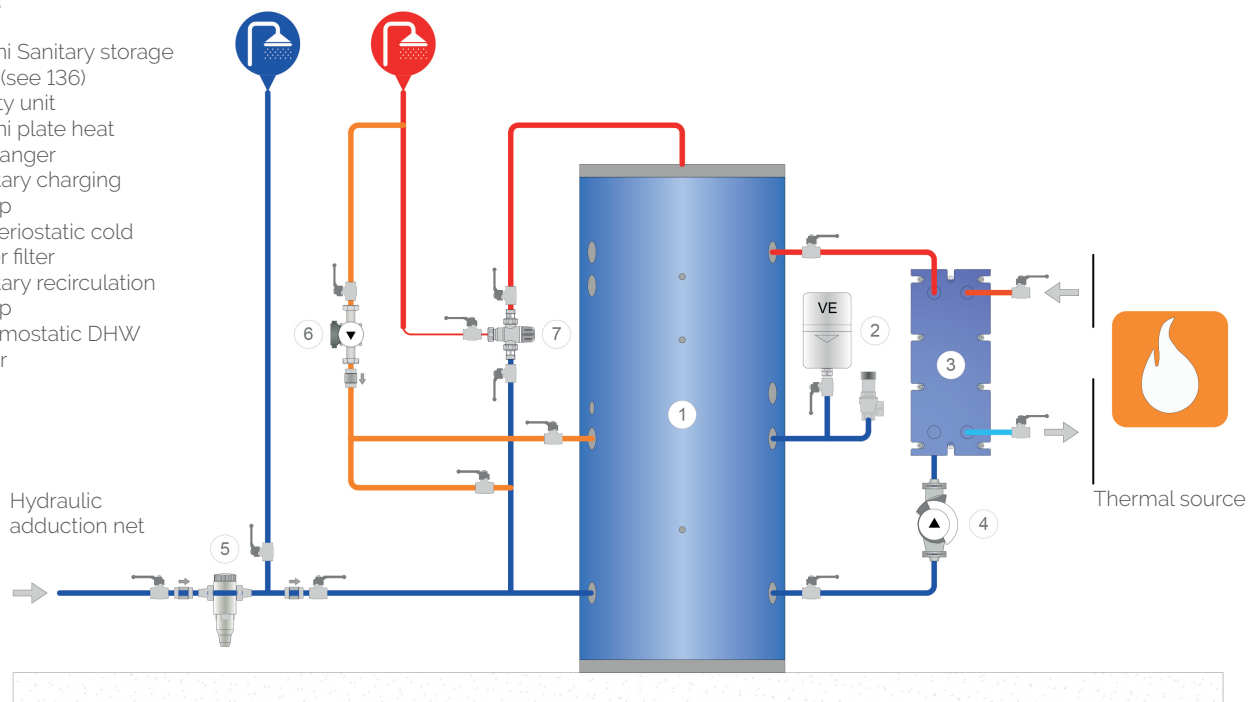

AFK fast heater see pag. 184

Plant Solutions

Separation between thermal source and device

(Closed expansion tank)

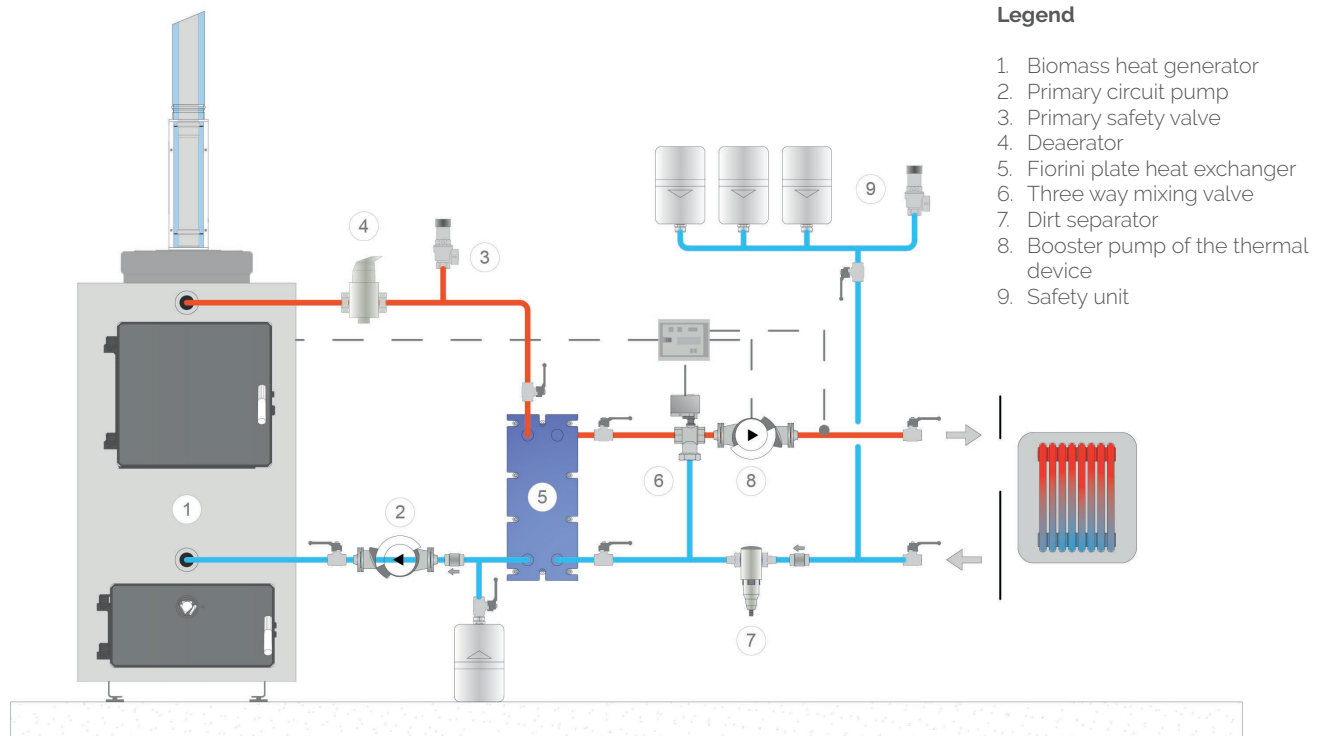

Separation between thermal source and device

(Open expansion tank)

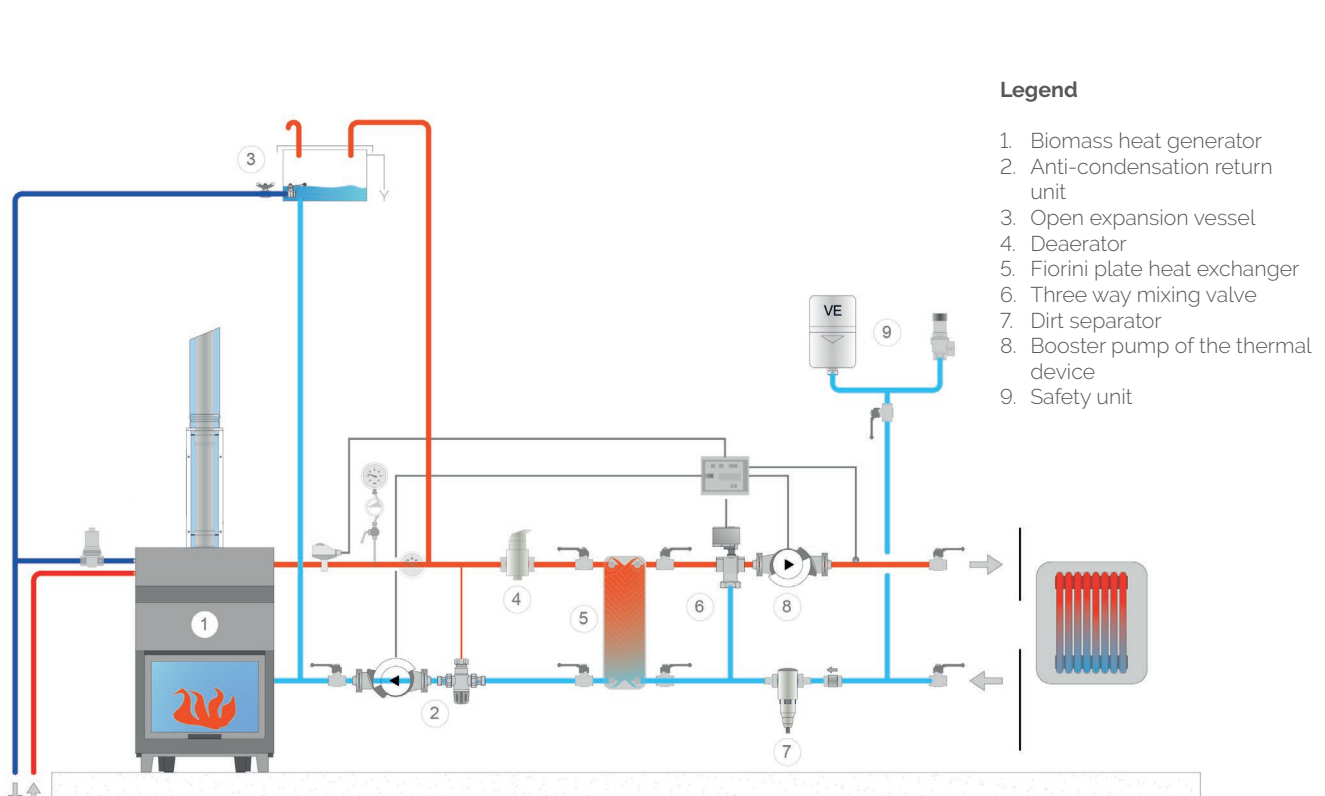

Plant Solutions

Systems for swimming pools

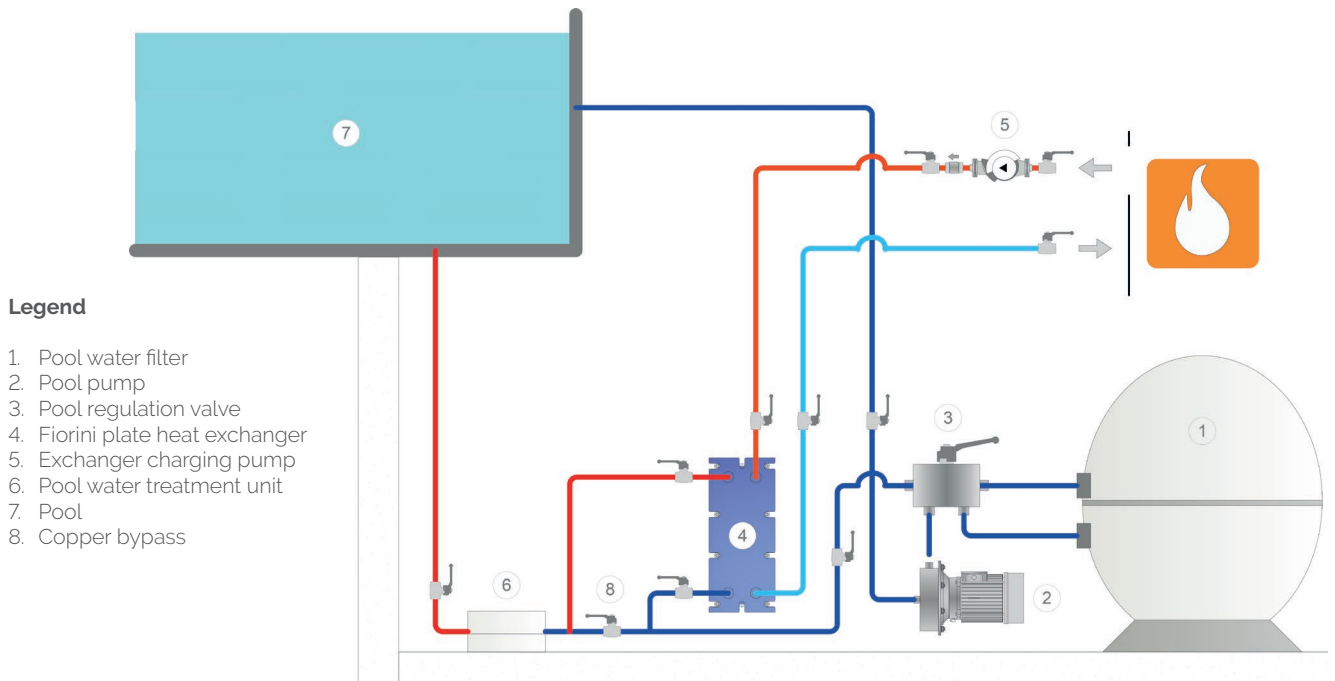

Systems for solar thermal

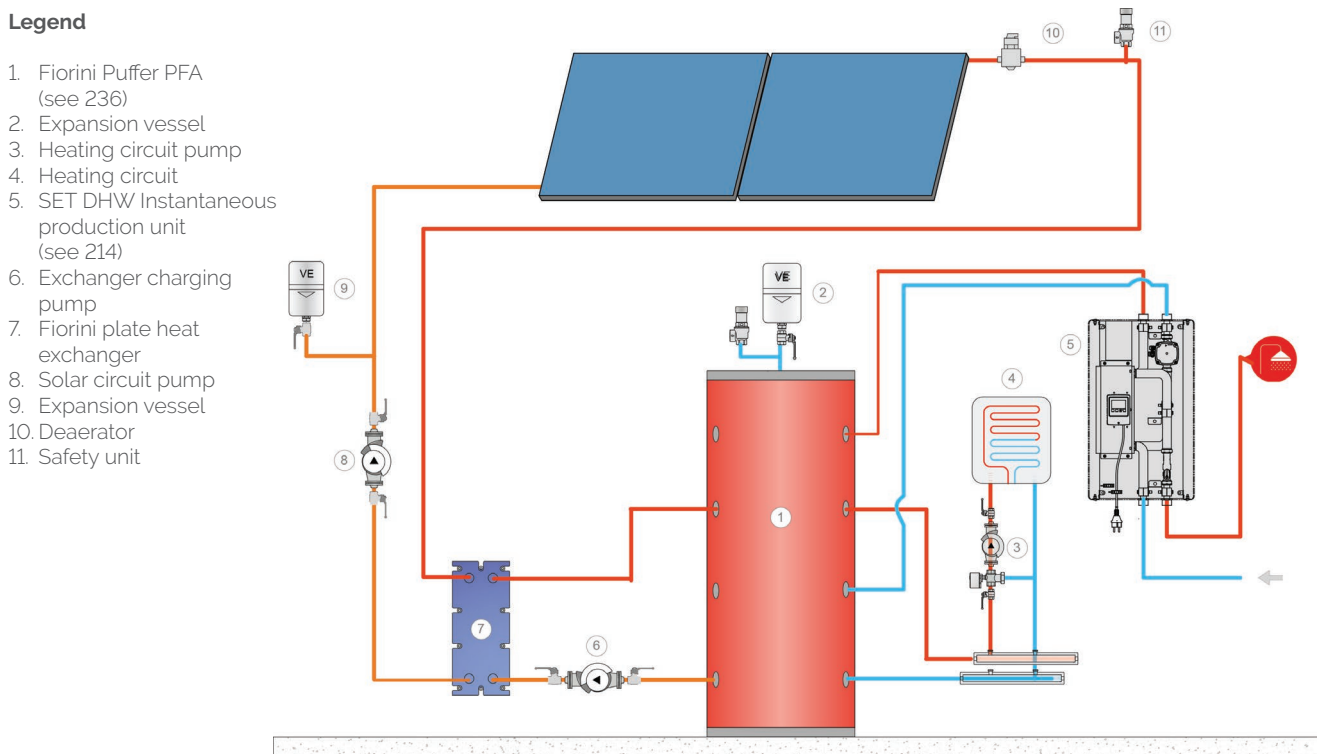

DATA COLLECTION FOR EXCHANGER SELECTION

For the correct dimensioning of an exchanger, at least 5 data on 7 * are mandatory and meet the following conditions:

- T.IN HOT > T.OUT COLD
- T.IN COLD < T.OUT HOT
- Temperatures and flow rates consistent with thermal power

If you do not know all the required data, describe the type of application in the appropriate field below.

CONTACT			
Applicant		Data	
Company		Ph.	
Email		Ref.	

GENERAL DATA			
Exchanger type	<input type="checkbox"/> Gasketed	<input type="checkbox"/> Brazed	
Power*		(specify u.m. kW or kcal/h)	
Nominal pressure		(specify u.m. e.g. bar)	

HOT SIDE	
Fluid	
T IN* (°C)	
T OUT* (°C)	
FLOW* (specify u.m.)	
MAX loss (kPa)	

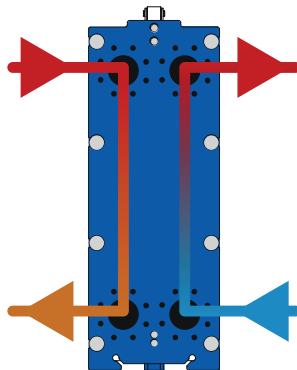

COLD SIDE	
Fluid	
T IN* (°C)	
T OUT* (°C)	
FLOW* (specify u.m.)	
MAX loss (kPa)	

ADDITIONAL NOTES			
Type/ Diameter Couplings			
Plates material/ Couplings/Shaft			
Accessories	<input type="checkbox"/> anti-condensate tub (only for gasketed)	<input type="checkbox"/> insulation box	<input type="checkbox"/> feet set (only for gasketed)
Size Limits			
Type of application			

The QR-CODE allows you to access the online form for the dimensioning of exchangers. Following the wizard you can send the completed form directly to our technicians, who will answer you with the sizing required in a short time.

How to use the QR-CODE:

- Use a device like tablet, smartphone, 2 in 1 device.
- Install an application to read QR-CODE (if not already installed)
- Aim the device on QR-CODE
- Access the form online

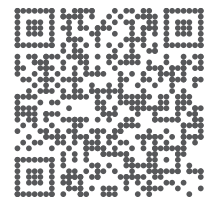

The personal data included in this form will be processed according to current laws about privacy. Please see the privacy notice, full text is available at go.fiorinigroup.it/eng/privacy
Filling this form you agree to the privacy notice and allow data processing.

 go.fiorinigroup.it/eng/dimensionamentophe



Download additional content

 go.forinigroup.it/eng/content

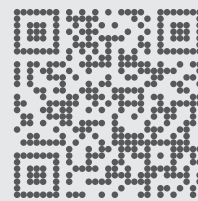

fiorini

Fiorini Industries S.r.l.
Ph. +39 0543 723197 – Fax +39 0543 720413
Via Zampeschi 119 – 47122 Forlì (FC) – Italy
www.forinigroup.it