

... just safely installed

multitubo
systems



INSTRUCTION AND MOUNTING MANUAL WELDING CONNECTIONS



Technical manual Welding connections MULTITUBO systems

1.0	P. 3	Handling welding tools
1.1.	P. 3	State before operation
1.2.	P. 4	Heating – up / Handling
1.3.	P. 5	Check-up
2.0.	P. 6	Welding
2.1.	P. 6	Types of connection
2.2.	P. 7	Mounting instructions
2.2.1.	P. 7	Preparation of the connection
2.2.2.	P. 8	Welding fitting connections 20 - 75 mm

Congratulations,

You decided to use the Welding connection technology from MULTITUBO systems. By using this connection technology you are using the welding Know-How for your projects. To enable a quick start and that you are going to be satisfied with the machine for a long time, we collected all relevant information for a secure use and which are appropriate for the involved materials in this technical manual. Please read carefully the following information before operation!

MULTITUBO systems

1.0 Handling welding tools

1.1. State before operation

Machine-type and power output
MULTIWELD Electro heat elements

Dimension 20 mm - 110 mm:
Power output: 1400 Watt
Voltage supply: 230 V - 50/60 Hz
Operating temperature: 220 - 240°C

IMPORTANT!

Just original MULTIWELD heat elements and MULTIWELD tools must be used.

The heat element must not be unattended at any time. Be aware that there is always enough distance to flammable objects. Pay attention of the welding tool temperature before assembling.

CAUTION - VERY HOT - DO NOT TOUCH!

1. Before fusing the heat element, the welding tools have to be placed into the respective holes of the heating place manually and fix them hand-tight.

2. After reaching the operating temperature eventually the welding tools must be retightened.

3. All welding tools must be free from impurities. Check, if they are clean before assembling. If necessary clean the welding tools with a non fibrous, coarse tissue and with spirit.

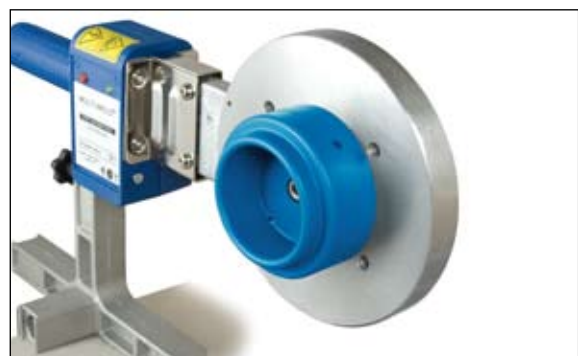
For cleaning purposes no sharp-edged objects must be used. Those could damage the coating of the welding tools and thus influence the welding result.

4. Place the welding tools on the welding device so that there is full, respectively as much as possible surface-contact between the welding tool and the heating plate. (for example see fig.1/fig. 2). The temperature of the welding-tools must be between 220°C and 240°C).

fig. 1: Example of dimensions 40 mm / 50 mm / 63 mm

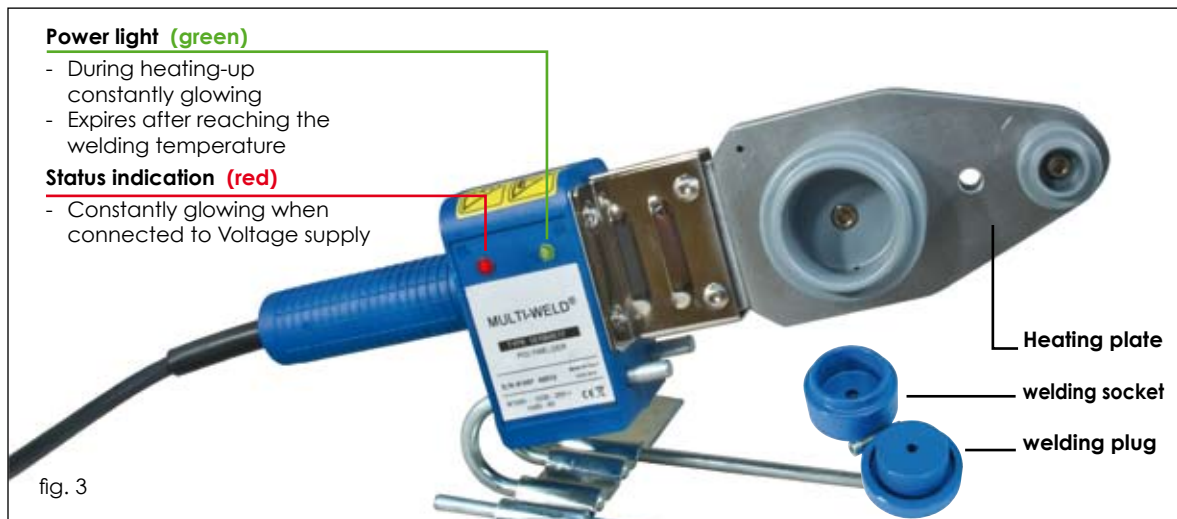


fig. 2: Example of dimension 75 mm



5. Plug in the welding device and check if the power light is on. Depending on the ambient temperature it takes 10 to 30 min to heat up the heating plate.

1.2. Heating – up / Handling



Heating - up

1. During the heating-up phase tighten the welding tools carefully with the clamp. Take care that the tools are in full contact with the heating plate. Do not use pliers or any other unsuitable tools, as this will damage the coating of the welding tools.

2. The required welding temperature of the MULTITUBO systems welding fittings is 220 - 240°C. Acc. to DVS Welding Guidelines the temperature of the welding device has to be checked at its tool before starting the welding process. The temperature check is done with a fast indicating surface temperature measuring instrument.

ATTENTION: The first welding can be done soonest 5 min after reaching the welding temperature! Just then fully heated welding tools are assured.

Handling

1. A tool change on a heated device requires another check of the welding temperature at the new tool after the heat-up time.

2. If the device has been switched off of a longer period, the heating-up process has to be restarted (see heating-up)

3. After use turn off the welding device it let it cool down. Never use water to cool the welding device. Otherwise the heating resistances would be damaged.

4. MULTIWELD welding machines and tools must be protected against impurity. Burnt particles may lead to an incorrect fusion. The tools can be cleaned with cleaning tissues. Keep the welding tools always dry.

5. After the welding process do not lay the tool on its Teflon coated tools. Place it on the included rack..

6. Damaged or dirty welding tools must be replaced. Just with technically flawless tools a proper welding connections can be secured.

7. Never attempt to open or repair defective devices. Return a defective device for repair.

8. To ensure a permanent and adequate function, the operating temperature of the MULTIWELD welding machines must be checked regularly by means of suitable measuring instruments.

9. For the correct handling of welding machines the “**General Regulations for Protection of Labour and Prevention of Accidents**” and particularly the “Regulations of the Employers Liability Insurance Association of the Chemical Industry regarding Machines **for the Processing of Plastics, (chapter: Welding Machines and Welding Equipment)**” must be observed.

10. For the handling of MULTIWELD welding machines, devices and tools please observe the “General Regulations DVS 2208 Part 1 of the German Association for Welding Engineering, Registered Society (Deutscher Verband für Schweißtechnik e.V.).

1.3. Checking of device and tools / observance of welding times

1. Checking of device and tools

The used device and tools must have reached the required welding temperature of between 220 and 240°C. According to the DVS Welding Guidelines the check of the required temperature has to be done with a fast indicating surface temperature measuring instrument.

Applicable measuring instruments must be suitable for temperature checks up to 350°C and must have a high measurement precision.

2. Observance of welding times

By using the welding timer the adequate welding progressing times can be kept easily. Thus inaccuracies can be avoided.

Use the MULTITUBO systems welding timer (Art.-No. 38019) as described following (fig. 6):

- a) Reset display (press MIN and SEC at the same time)
- b) Enter the required seconds by pressing the SEC button (please consider the increased heat up time for an ambient temperatures below +5°C – table 1)
- c) After the welding tools have reached the processing temperature, insert the prepared pipe and fitting rapidly onto / into the tools and start the welding timer (button START/STOP)
- d) Remove pipe and fitting rapidly from the welding tool after the acoustic signal and connect them.



fig. 4

Checking of the temperature with a surface temperature measuring instrument.



fig. 5

Example of a surface temperature measuring instrument which is available in the market.



fig. 6

MULTITUBO systems with indicated welding times.

2.0 Welding

2.1. Types of connection

The MULTIWELD Welding fitting system consists of two components:

A – Welding of fitting with the pipe

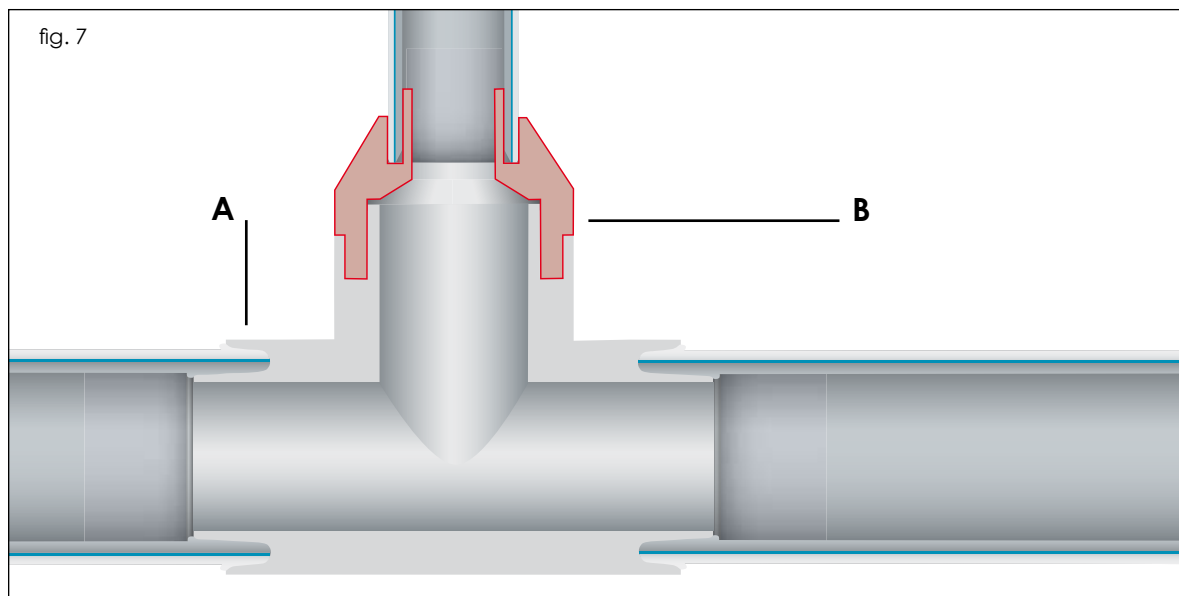
B – Welding of fitting with adapter fittings, to connect reductions at couplings, elbows and T-pieces.

The fitting connection end of the adapter fittings that are welded into the fittings, have the same dimension as the pipe and thus to be used similar as welding the pipe into the fittings.

Important:

The welding- and cooling-off times depend on the dimension. This is valid for type A (Welding of fitting with the pipe) as well as for type B (Welding of fitting with adapter fittings)

The relevant specifications for the welding process - mentioned in table 1 - must be absolutely followed.



A - Pipe directly welded into the fitting body

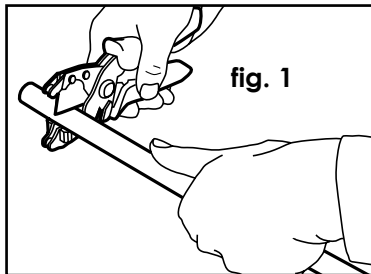
B - Reduction by using an adapter fitting

2.0 Welding

2.2. Mounting instructions

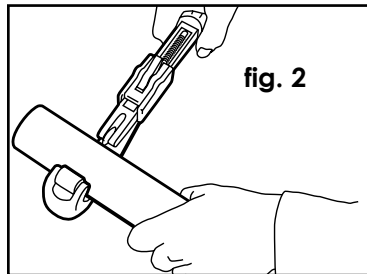
The mounting instruction must be considered! The components of system are harmonised and tested. For outside supplied components we do not incur any warranty. In particular the preparation of the pipes is valid for all types of connection.

2.2.1. Preparation of the connection

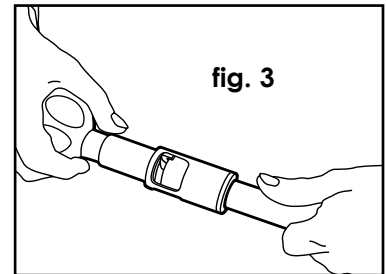


1. 1. Cut to length of the pipe

16 mm – 20 mm (fig. 1)
Cut the MULTITUBO systems pipe right-angled with the pipe cutter

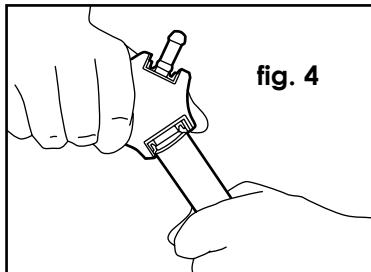


25 mm - 75 mm (fig. 2)
Cut the MULTITUBO systems pipe right-angled with the pipe cutting tool.



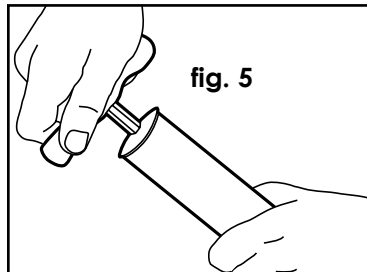
2. Centering and bevelling of the pipes

16 mm – 32 mm (fig. 3)
Bevel the MULTITUBO systems Multilayer pipe by using the bevelling insert in combination with the handle until there is a clearly visible edge all over the pipe end.

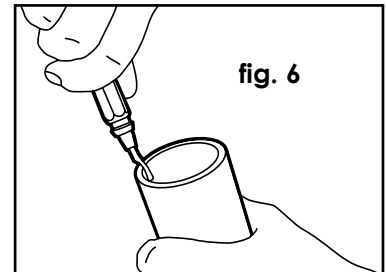


IMPORTANT : NOT FOR PUSH-FITTINGS

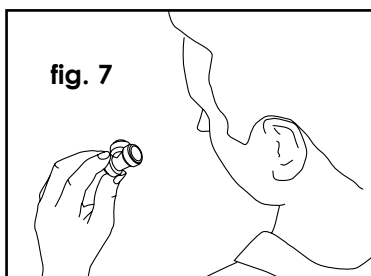
Alternative: 16 mm – 25 mm (fig. 4)
Use the Combined Bevelling Tool for press- or welding connections to make a clearly visible edge all over the pipe end..



40 mm – 75 mm (fig. 5)
Use the Bevelling Tool MULTIWELD until there is a clearly visible edge all over the pipe end.

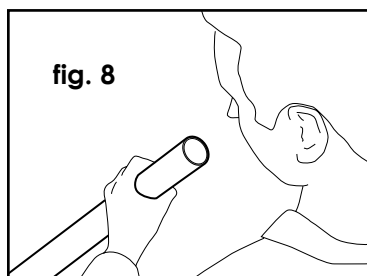


IMPORTANT: ONLY FOR WELDING CONNECTIONS
Alternativ: 32 mm – 75 mm (fig. 6)
Make a visible edge all over the pipe end by using the Bevelling Tool. Please be aware of the roundness of the pipe!



3. Inspection of the pipe edge before welding

Make an optical check if there are any impurities (fig. 7).



4. Inspection of the edge before welding

Make an optical check if there is a clearly visible edge all over the pipe end (fig. 8 + fig. 9).

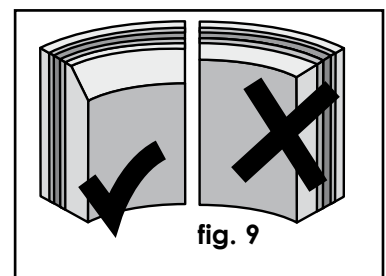
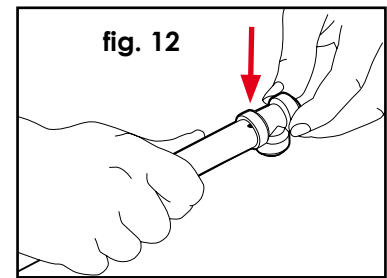
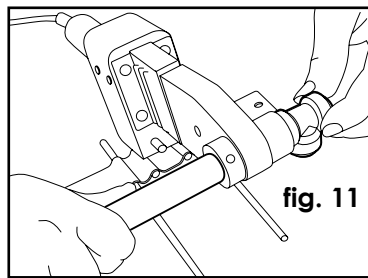
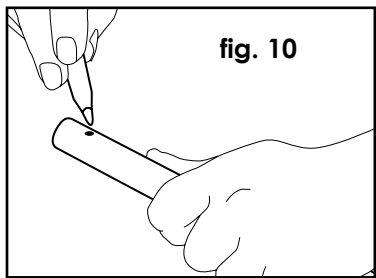


fig. 9

2.0 Welding

2.2.2. Welding fitting connections 20 mm - 75 mm



1. Assembling Welding fitting

IMPORTANT

TO INSURE A SECURE CONNECTION ALL INSTRUCTIONS, ESPECIALLY THE SAFETY INSTRUCTIONS, TEMPERATURES AND PROCESSING TIMES, MUST BE CONSIDERED.

- a) Preparation of the MULTITUBO systems Multilayer pipe as described under 2.2.1..
- b) For the MULTITUBO systems welding fittings just MULTITWELD welding machines must be used.
- c) To insure a perfect connection of pipe and fitting all parts must be free from deposits and free of grease. Eventually the pipe and fitting must be cleaned before welding and protected against an anew impurity. Be aware that the fittings could not get in touch with grease or other similar materials during storage and transport.
- d) Heat up the welding machine according to the instructions
- e) Mark the insertion depth of the pipe into the fitting on the pipe (see table 1, insertion depth). (fig. 10)
- f) Insert the pipe into the plug and at the same the fitting onto the socket. Insert straight, don't turn or align! (fig. 11)
- g) The Heat up time starts when pipe and fitting are fully inserted.
- h) After the prescribed heat-up time remove pipe and fitting rapidly from the welding machine and put both directly and without turning / align them together. The correct insertion depth must be checked by the previous marked check mark. (fig. 12)
- i) The pipe must not be overheated or inserted too deep. That would cause counterproductive narrowing flow channels by the flowing material.
- j) During the processing-time the connection can be adjusted a little bit but the pipe must not be turned inside the fitting. After that the connection must be fixed to prevent it from unexpected impacts.
- k) After the cooling-off time the connection is able to work under full pressure.

Important:
The insertion depths, the times for heating-up, processing and cooling-off d must be followed!

Table 1 – Relevant specifications for the welding process

PIPE-OUTER-Ø	INSERTION-DEPTH	HEAT-UP TIME*	PROCESSING - TIME**	COOLING OFF TIME	
mm	mm	sec.	sec.	min.	
20	5	5	4	10	For an ambient temperature below +5° the heat up time must be increased of 50%. * The recommended heat up time from MULTITUBO systems at a device temperature between 220 °C to 240 °C. ** After that period the pipe must not be inserted into the connection any longer.
25	5	6	4	10	
32	6	6	4	10	
40	7	10	5	15	
50	8	12	5	15	
63	9	12	5	15	
75	9,5	14	6	20	