

MFH PLANNING

MODULAR. FLOOR HEATING. 20 mm.

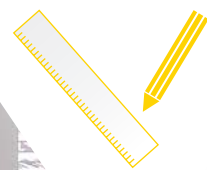

69 W/m²
35/30 °C

VarioComp.

TABLE OF CONTENTS

1	PRINCIPLES	4
1.1	Comfort	4
1.2	Energy savings	5
1.3	Is it possible to cool a room using the floor?	5
1.4	Description and advantages of the VarioComp floor heating	6
2	COMPONENTS	8
2.1	Overview	8
2.2	VarioProFile pipe 11.6x1.5 Laser	10
3	FLOOR STRUCTURE	11
3.1	General	11
3.2	Prerequisites as a suitable substructure	11
3.3	VarioComp on an existing subsurface	12
3.4	VarioComp on dry construction with load distribution layer	12
3.5	VarioComp on an existing subsurface + Insulation	13
3.6	Impact sound insulation	13
4	MOVEMENT JOINTS	14
5	THERMAL OUTPUT	15
5.1	Calculating the heating load	15
5.2	Variotherm dimensioning software	15
5.3	Heat output tables	16
6	PIPING	19
7	PRESSURE LOSS	20
8	FLOOR COVERING	22
8.1	General	22
8.2	Residual humidity of the VarioComp filling compound	22
8.3	Borders between VarioComp panels and blank panels (at bonding of floor coverings)	23
8.4	Levelling out with a calcium sulphate floor levelling compound	23
8.5	Compound sealing in rooms exposed to high humidity	24
8.6	Stone and ceramic coverings	25
8.7	Linoleum, carpet, PVC floor covering and synthetic resin floors	25
8.8	Wood covering, parquet and laminate	26

1 PRINCIPLES

Variotherm recommends a combination of floor, wall and ceiling. In general, walls offer the largest exchange area, which is why wall heating/cooling systems ensure that people can easily feel the radiant heat.

The Variotherm floor heating system is ideal for all 'cold' floors. It is an optimum temperature regulator, creating a pleasant atmosphere. The Variotherm floor heating emits long-wave, infrared radiant heat. Consistent with the body's own heat, similar to the heat of the sun, this type of heat is experienced as particularly pleasant.

	Heating	Cooling
Ceiling	++	+++
Wall	+++	+++
Floor	++	+

▲ Which system areas are suitable for which needs?

1.1 Comfort

Comfort is not only created through a certain air temperature in the room. The temperature of the surfaces enclosing the room is of equal importance. The felt temperature is roughly consistent with the arithmetic mean of both temperatures.

What makes people feel comfortable?

People feel comfortable when the following basic 'thermal comfort' equation holds:

$$\text{Heat production} = \text{heat loss}$$

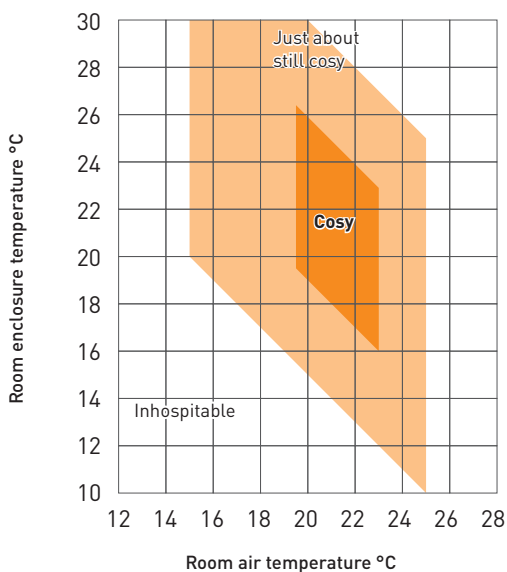

▲ Zone of cosiness

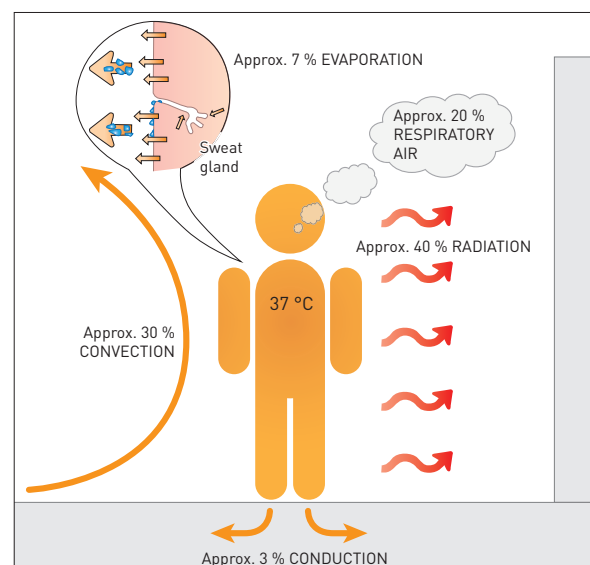

▲ Human heat balance

In this context, it is important that the heat loss from the human body is as evenly distributed in all directions as possible. We feel uncomfortable if too much heat is lost in one particular direction (cold surfaces, draughts) or heat loss is prevented in one direction (hot surfaces or steam-tight, thick clothing). In many cases it is therefore recommendable to install a combination involving the Variotherm wall heating system. Consistent heat transfer ensures that temperature layering in the room is kept at a minimum, promoting the general spreading of a pleasant temperature. In the case of floor heating, the floor is indeed warmer than the air at head-level. Indeed, according to popular wisdom, people 'stay healthy with a cool head and warm feet'. The room temperature can be set lower than with conventional heating systems. Radiant heat raises the felt air temperature without affecting your comfort.

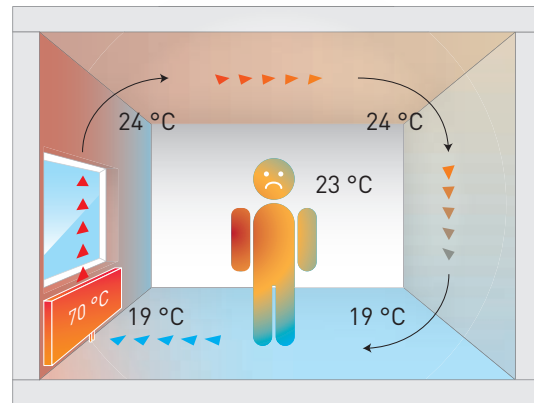

▲ Discomfort with radiators

Since the heat is transferred invisibly via the floor, no visible components have to be planned for, such as recesses for heating devices, radiators and pipes. These almost unavoidable 'subtenants' in expensive living space require a lot of room and are not pleasing to the eye. They restrict both the wall and window design and the space where furniture can be positioned.

Combined floor heating and wall heating systems complement each other perfectly in living spaces. They allow for tailor-made heat supply in every room.

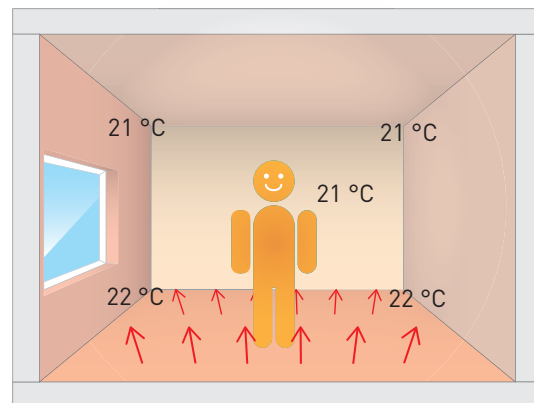

▲ Comfort with floor heating system

1.2 Energy savings

The right surface heating/cooling system not only gives you optimum comfort, it also saves energy and money. The cost of operating a floor heating system can be reduced due to low surface temperatures and hence low heating water temperatures. Surface heating/cooling is therefore ideal where low-temperature energy sources are used, such as biomass, heat pumps, condensing boilers and solar collectors.

The approximate cost savings per 1 K (°C) lower room air temperature are 6 %. Low room air temperature also has the great physiological advantage of significantly increasing the absorption of oxygen.

1.3 Is it possible to cool a room using the floor?

Cooling via the floor is possible. Real room cooling is only possible in combination with additional areas on the ceiling and/or wall.

1.4 Description and advantages of the VarioComp floor heating

The VarioComp floor heating system is ideally suited for retrofitting a floor heating system.

All components of the complete system are perfectly matched:

- The specially milled routings of the VarioComp panel
- The easy to bend VarioProFile pipe with an extremely stable form
- The ideal height for the optional XPS or SILENT underlay panel
- The fast-drying VarioComp filling compound

All this makes for the perfect combination – right down to the smallest detail.

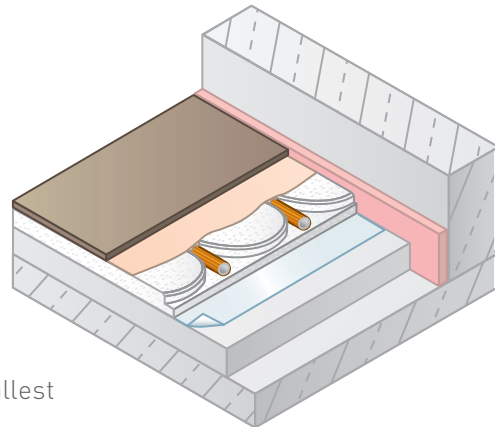

The fast reaction time allows good control of the room temperature even in sunny rooms. The complete system has been checked, tried out in practice and has been awarded with a number of quality certificates.

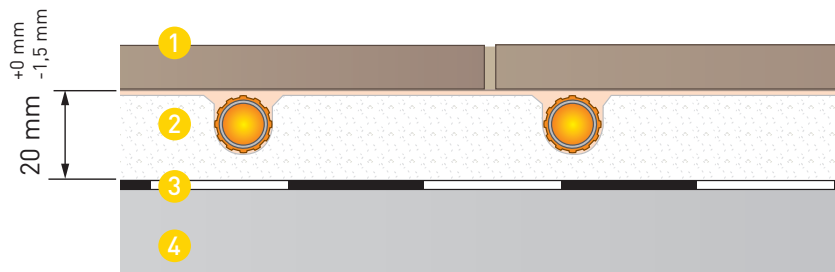

- 1 Floor covering
- 2 VarioComp floor heating
- 3 Construction foil
- 4 Subsurface

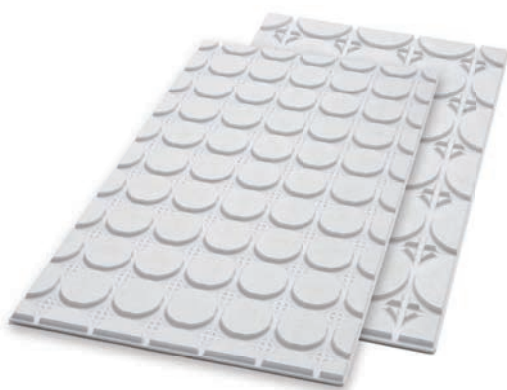

▲ VarioComp panels
(pipe spacing 100 or 150 mm)



▲ VarioProFile pipe 11.6x1.5 Laser



▲ VarioComp filling compound

The advantages and applications of VarioComp floor heating system:

- System is only 20 mm high (+ 0 mm; -1.5 mm)
- Low weight of only 25 kg/m²
- Surface ready for laying the floor covering or further processing (see chapter 8)
- Fast installation, e. g. tiles can be laid after only 24 hours
- Ideal for renovations
- Continuous nap system allows free laying of pipes
- Fast reaction times:

The VarioComp floor heating was subjected to comparison measurements with a screed floor heating system (VarioRoll, pipe spacing: 100 mm, screed covering of the VarioProFile pipe: 40 mm) for 24 hours.

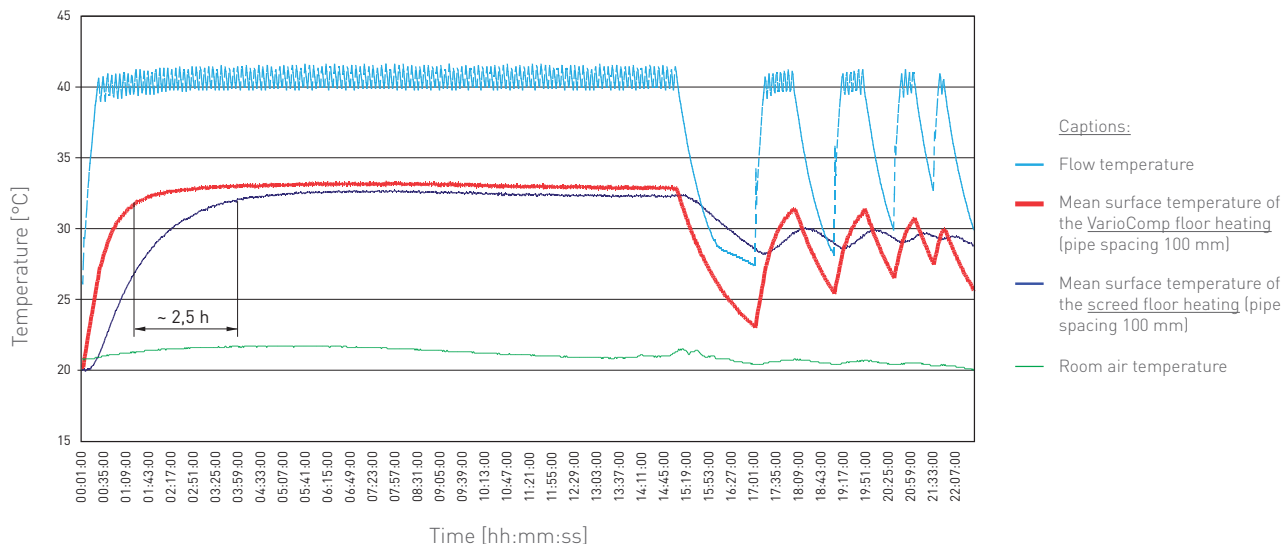

The faster heating of the surface of the VarioComp floor heating compared to the screed floor heating system can be clearly seen. The reaction time of the surface temperatures to reduced flow temperature is shorter. This results in:

- Better control of the VarioComp floor heating. The surface temperature during heating is greater than that of the screed floor heating system.
- More efficient layout of the heating surfaces because lower flow temperatures than those used for other floor heating systems are possible.

2 COMPONENTS

2.1 Overview

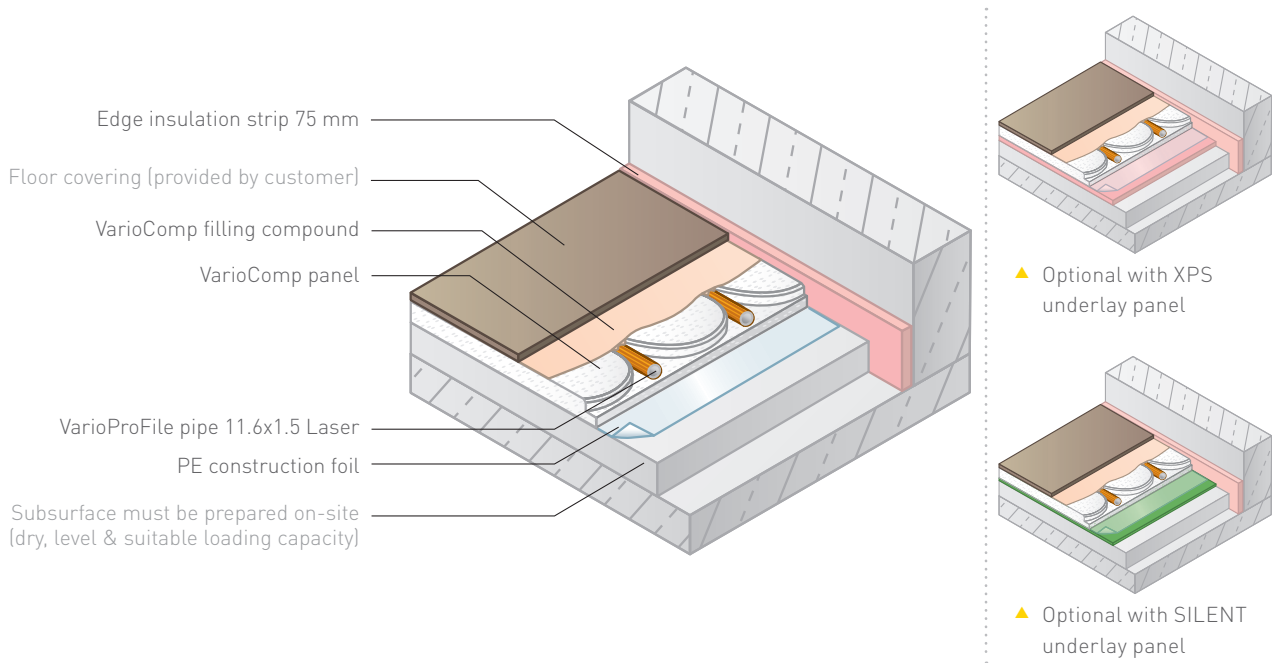

VarioComp panels / blank panel

PG 032

Gypsum fibre board which has been tested for their healthy building properties 18 mm.
Pipe bracket and heat conducting panel for pipe spacings of 100 mm or 150 mm (150 mm not recommended for living or bare-foot areas!).

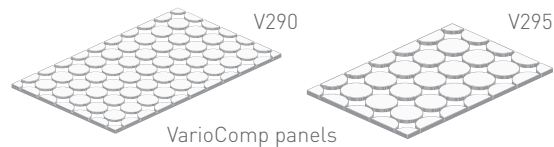

Blank panels to compensate for free remaining areas without laid pipes (e.g. kitchen units).

Part No.	Pipe spacing	Dim. [mm]	A [m ²]	PKU	Weight/PKU	Pallet
V290	100 mm	1000 × 600	0.60	0.60 m ²	9.6 kg	30 m ²
V295	150 mm	900 × 600	0.54	0.54 m ²	9.6 kg	27 m ²
V021-029	-	1000 × 600	0.60	0.60 m ²	12.6 kg	30 m ²

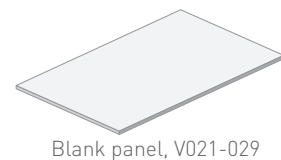

VarioProFile pipe 11.6x1.5 Laser

PG 050

Profiled surface structure guarantees optimum heat transfer.
For details see chapter 2.2.



Part No.	PKU	Weight/PKU	Pallet
VP116L-100	100 m roll	7.0 kg	18 rolls
VP116L-300	300 m roll	18.0 kg	12 rolls
VP116L-500	500 m roll	30.0 kg	8 rolls
VP116L-800	800 m roll	44.8 kg	5 rolls

Compact filling compound T7

PG 032

Special filling compound for filling out the laid VarioComp panels with inserted VarioProFile pipe 11.6x1.5 Laser.

Maximum storage time is 12 months.
Consumption:
approx. 6.0 kg/m² with V290,
approx. 4.8 kg/m² with V295



Part No.	PKU	Weight/PKU	Pallet
V291	1 bag	25 kg	42 bags

Compact XPS and SILENT underlay panels

PG 030

For use as a thermal/impact-sound insulation panel directly beneath VarioComp floor heating.

The ideal addition between non-insulated subsurfaces (such as even screed) and the VarioComp panel.

V2898: extruded polystyrene foam (thermal insulation)

V2899: wood fibre board (sound-impact insulation)

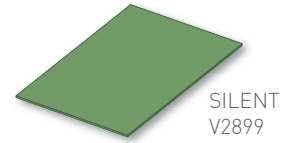
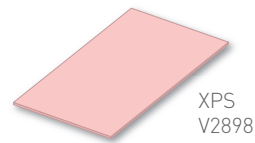

Part No.	Dim. [mm]	Thickness	Compressive strength at 10 % compression	Thermal conductivity	Impact sound reduction ΔL_w PKU	Weight/PKU	Package
V2898	1250 x 600	10 mm	200 kPa (20 t/m ²)	0.035 W/mK	up to 14 dB	0.750 m ²	30 m ²
V2899	790 x 590	5 mm	150 kPa (15 t/m ²)	0.071 W/mK	up to 17 dB	0.466 m ²	7 m ²

PE construction foil

PG 030

for laying under the VarioComp panel, transparent recycled material, 0.1 mm thick.

Dimensions: 1030 mm x 50 m = 51.5 m²

Usable area: 1000 mm x 50 m = 50.0 m² (with a 30 mm overlap)

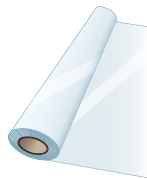

Part No.	PKU	Weight/PKU
V2895	50 m ² roll	5.1 kg

Edge insulation strip 75 mm

PG 030

as per EN 1264-4, 75 mm high, 10 mm thick, made of PE foam, front side with self-adhesive, welded overlapping foil for the sealed connection of edge insulation strips and PE construction foil, rear side with butyl rubber adhesive strips.

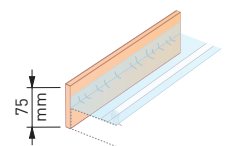

Part No.	PKU	Weight/PKU	Bag
V299	25 m roll	0.8 kg	16 rolls

VarioComp mixing tool

PG 140

the perfect mixing tool for mixing the VarioComp filling compound. Diameter 120 mm, required power for drive 1000 W, 600 min⁻¹, min. drill chuck 13 mm



Part No.	PKU	Weight/PKU
W030	1 pce.	715 g

Bucket set

PG 140

Bucket set consisting of:

- Water bucket for the correct dosage
- 30 litre bucket for mixing the VarioComp filling compound



Part No.	PKU	Weight/PKU
W028	1 Set	1.2 kg

Scraper 600 mm

PG 140

with telescopic shaft and shaft holder, for spreading the VarioComp filling compound

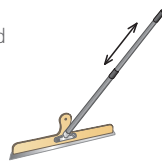

Part No.	PKU	Weight/PKU
W029	1 pce.	1.0 kg

VarioBar 11.6/77

PG 015

for affixing the VarioProFile pipes 11.6x1.5 Laser (supply pipe) in the area in front of the heating distribution manifold. PE VarioBar with an installation height of only 17 mm. Grid spacing 38.5 mm



Click technology:



Part No.	PKU	Weight/PKU	Carton
V2722	1 m	100 g	50 x 1 m

Adhesive tape

PG 031

for gluing the PE construction foil
Roll: 50 mm x 66 m



Part No.	PKU	Weight/PKU	Carton
V288	1 pce.	210 g	36 pcs.

Cold shrinking tape

PG 100

for optimum corrosion resistance of press-fit coupling connections as per ÖN H 5155. Roll: 50 mm x 15 m, 1 roll is sufficient for approx. 35 press-fit coupling connections (with a 50 % overlap)



Part No.	PKU	Weight/PKU	Carton
Z1699	1 pce.	990 g	20 pcs.

2.2 VarioProFile pipe 11.6x1.5 Laser

Advantages

- Fully corrosion-free
- As light as a plastic pipe
- 10-year guarantee with certificate
- Optimum behaviour under long-term stress
- Profiled surface structure guarantees optimum heat transfer
- Flexible, easy to bend, extremely good hydrostatic stability
- Resistant to hot water additives (inhibitors, antifreeze)
- Mirror-smooth inner surface – less pressure loss – no encrustation
- High pressure and temperature resistance (10 bar, +95 °C)
- 100 % oxygen diffusion-tight
- Lower linear coefficient of expansion, lower heat expansion forces
- Tested as per EN 21 003, SKZ A 397

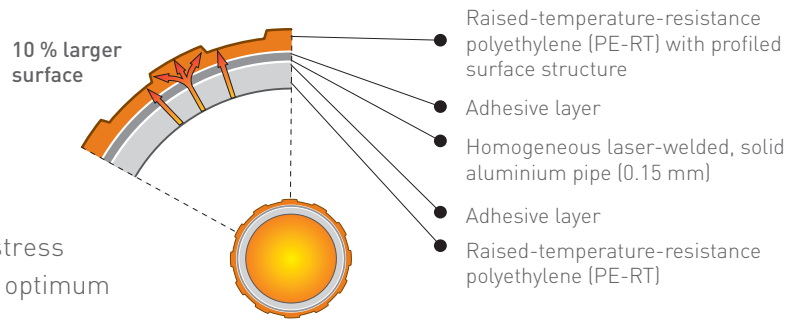

Elongation

with 10 m and temperature difference Δt 25 °C (e.g. 20 °C to 45 °C):

	Tubing	Elongation
Plastics	PEX/VPE	50.00 mm
	PP	42.50 mm
	PB	32.50 mm
	PVC	20.00 mm
	VarioProFile pipe	5.75 mm
Metall	Cu	4.20 mm
	Stainless steel	3.50 mm
	Steel	2.88 mm

Homogeneous plastic pipes produce high stress levels in the device because of their expansion coefficient.

The VarioProFile pipe combines the minor elongation and thermal expansion. So it is perfect for surface heating- and -cooling pipes.

Technical data

Pipe diameter:	11.6 mm
Pipe wall thickness:	1.5 mm
Aluminium pipe thickness:	0.15 mm
Roll length:	100, 300, 500 and 800 m
Water content:	0.058 l/m
Special narrow bending radius (use a suitable bending device):	30 mm
Max. operating temperature [t_{max}]:	95 °C
Short-term resistant [t_{mal}]:	110 °C
Max. operating pressure [p_{max}]:	10 bar
Linear expansion coefficient:	$2.3 \times 10^{-5} [K^{-1}]$
Mean heat conduction coefficient [λ]:	0.43 W/mK
Heat transmission resistance [R_{λ}]:	0.0033 m ² K/W

Creep behaviour

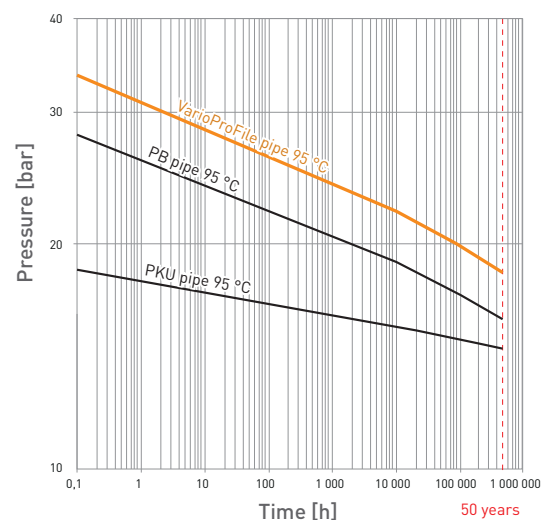

3 FLOOR STRUCTURE

3.1 General

The VarioComp panel is a pure tube carrier and thermal conduction element - and should therefore be regarded as a floor covering and not as a component of the floor structure. Why? The necessary static support, heat and impact sound insulation and protection against moisture diffusion must already be provided by the construction underneath the VarioComp panel.

The following items must be coordinated between the architect, construction manager, installation technician and floor layer:

- Horizontal level line
- Floor structure with Strength appropriate to the level of use, necessary vapour retarders/barriers, necessary thermal insulation/impact sound insulation and expansion joints
- VarioComp filling compound to be applied by installer, floor layer or construction manager
- Floor covering, with heat sensors if necessary

3.2 Prerequisites as a suitable substructure

The substructure must be checked by the planner for suitability! Furthermore, coordination should take place between all trades involved regarding the overall progress of construction work, including follow-up work.

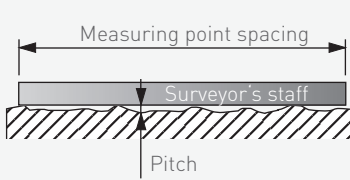
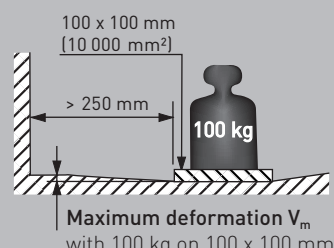
1. DRY	2. LEVEL	3. LOAD-BEARING																
<p>The subsurface must be dry, dust-free and grease-free. Maximum residual humidity of the subsurface (CM values):</p> <ul style="list-style-type: none"> • Untreated concrete: 3.0 % • Cement screed: 2.0 % • Calcium sulphate screed: 0.5 % 	<p>The required evenness is as follows (ÖNORM DIN 18202):</p> 	<p>Calculation of load-bearing capacity:</p> 																
<table border="1" style="width: 100%; text-align: center;"> <thead> <tr> <th colspan="4" style="background-color: #FFD700;">Measuring point spacing</th> </tr> <tr> <th style="background-color: #FFD700;">0.1 m</th> <th style="background-color: #FFD700;">1 m</th> <th style="background-color: #FFD700;">4 m</th> <th style="background-color: #FFD700;">10 m</th> </tr> </thead> <tbody> <tr> <td style="background-color: #FFD700;">1 mm</td> <td style="background-color: #FFD700;">3 mm</td> <td style="background-color: #FFD700;">9 mm</td> <td style="background-color: #FFD700;">12 mm</td> </tr> <tr> <td colspan="4" style="background-color: #FFD700;">Max. pitch</td> </tr> </tbody> </table>	Measuring point spacing				0.1 m	1 m	4 m	10 m	1 mm	3 mm	9 mm	12 mm	Max. pitch					
Measuring point spacing																		
0.1 m	1 m	4 m	10 m															
1 mm	3 mm	9 mm	12 mm															
Max. pitch																		

The load-bearing capacity specified in the table below must be provided. If there are several concentrated loads, these must be at least 500 mm apart.

Caution: The sum of the concentrated loads must not exceed the maximum permissible floor load capacity. Particularly heavy objects (pianos, aquariums, bathtubs) must be given special consideration!

Room usage examples in accordance with ÖNORM EN 1991-1-1 ÖNORM EN 1991-1-1	Max. concentrated load Q_k	Max. service load q_k	Max. deformation V_m (with 100 kg on 100 x 100 mm)
Category A1: Floors of rooms in residential buildings and houses, wards and hospital rooms (without heavy diagnostic instruments), rooms in hotels and lodgings, kitchens, toilets and rooms with residential-type use in existing buildings Category B1: Office floors in existing buildings	2.0 kN	2.0 kN/m ²	1.5 mm
Category B2: Office floors in office buildings Category C1: Floors in rooms with tables etc., e.g. classrooms in schools, cafés, restaurants, food halls, reading rooms, reception rooms, wards and hospital rooms (with heavy diagnostic instruments)	3.0 kN	3.0 kN/m ²	1.0 mm
Category C2: Floors in rooms with fixed seating, e.g. in churches, theatres, cinemas, conference rooms, lecture halls, meeting halls, waiting rooms, train station waiting rooms	4.0 kN	4.0 kN/m ²	(Floor structure on request)

3.3 VarioComp on an existing subsurface

Subsurface must be dry, level and of suitable loading capacity (see chapter 3.2)

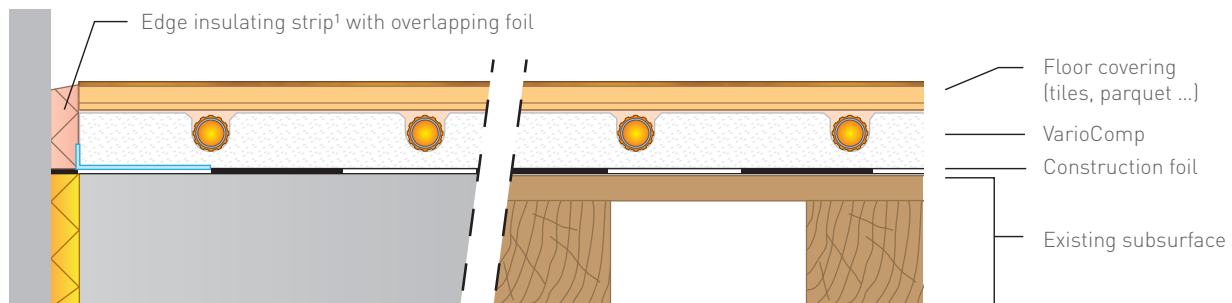

Screed:

- Test for evenness, and if necessary, even out using levelling compound.
- Test for dryness.

Bare slab:

- Test for evenness, and if necessary, even out using levelling compound.
- Building sealant, if required.

Wooden beam ceiling:

- Check bending, surface evenness and load-bearing capacity (see e. g. max. deformation V_m , Chapter 3.2); reinforce construction if required

3.4 VarioComp on dry construction with load distribution layer

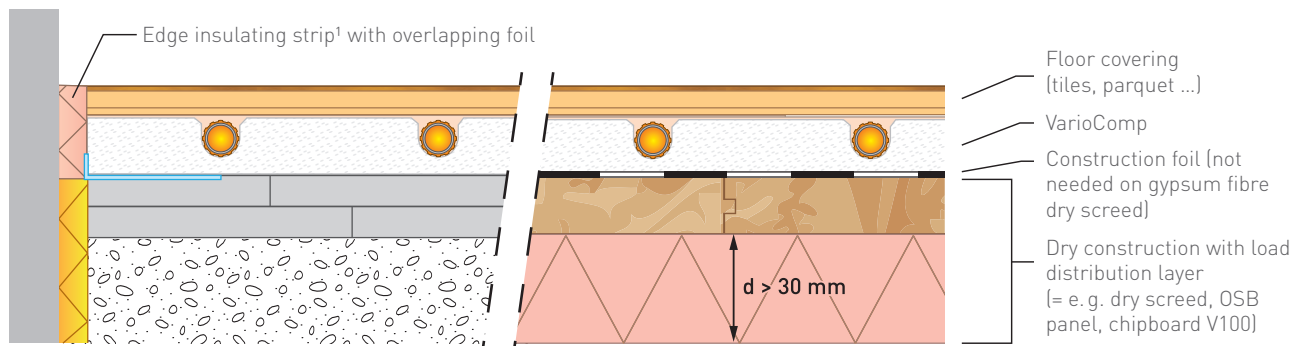

Fill

- Loose fill (note required compaction)
- Bonded fill (dry pipe density 350 kg/m^3 , compression strength $0.4\text{--}0.5 \text{ N/mm}^2$)
- Trickle protection sheet, if required

Load distribution layer necessary, e.g.:

- 20 mm dry screed element, processing according to manufacturer's instructions
- 2 x 15 mm OSB panel, adhered and screwed
- 2 x 19 mm chipboard (V100), adhered and screwed

Thermal insulation/impact sound insulation:

Insulation $d > 30 \text{ mm}$ or compressive strength $< 200 \text{ kPa}$ (20 t/m^2) with 10 % compression

Load distribution layer necessary, e.g.:

- 18 mm OSB panel, tongue and groove bonded
- 19 mm chipboard (V100), tongue and groove bonded
- 25 mm dry screed element, processing according to manufacturer's instructions
- 2 x 15 mm OSB panel, adhered and screwed
- 2 x 19 mm chipboard (V100), adhered and screwed

¹ Edge insulating strips are to be applied along the exterior walls, including columns, steps, door frames, pillars and shafts. They prevent sound and thermal bridges and allow the VarioComp floor heating to expand.

3.5 VarioComp on an existing subsurface + Insulation

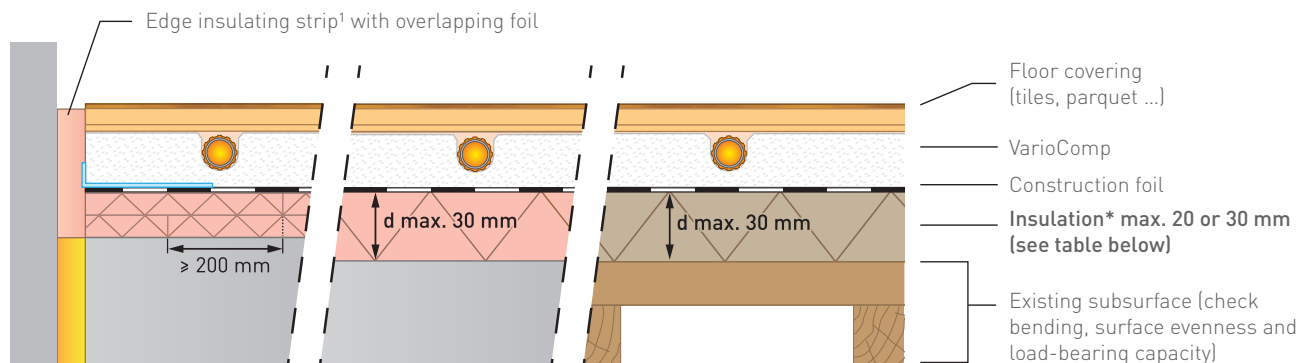

Thermal/impact sound insulation up to 20 mm:
Minimum compressive strength 200 kPa (20 t/m²) with 10 % compression

Thermal/impact sound insulation up to 30 mm:
Minimum compressive strength 300 kPa (30 t/m²) with 10 % compression

Product examples for thermal/impact sound insulation panels see table:

* Panels with insulation d max. 20 mm, compression strength minimum 200 kPa (20 t/m ²) with 10 % compression (room usage A1/B1 (see table chapter 3.2))	* Panels with insulation d max. 30 mm, compression strength minimum 300 kPa (30 t/m ²) with 10 % compression (room usage A1/B1 + B2/C1 (see table chapter 3.2))
Insulation panels and base panels	
Variotherm XPS underlay panel (10 mm) Styrodur 2800C Austrotherm Universalplatte / Uniplatte DOW Styrofoam LB-A/LBH-X/RTM-NC-X, Floormate 200-A Unifloor Jumpax CP/Heat-Pak Jackon Jackodur CFR 300	Styrodur 3035CS Austrotherm XPS Top 30 Foamglas T4+ DOW Floormate 500-A, Styrofoam LB-A/LBH-X/RTM-NC-X Kingspan Styrozone H 350 R Jackon Jackodur CFR 300 Unifloor Jumpax CP/Heat-Pak
XPS panels with plastered weave on both sides	
Wedi Bauplatte Jackon Jackoboard PCI (BASF) Pucidur	Wedi Bauplatte Jackon Jackoboard PCI (BASF) Pucidur
Wood fibreboard (Thermal/impact sound insulation panels)	
Variotherm SILENT underlay panel (5 mm, 150 kPa). (sound impact improvement 17 dB, measured on a thick, bare reinforced concrete floor) Steico Universal/Underfloor Pavatex Isolair L22 Gutex Multiplex-top	-
Impact-sound insulation panels	
Ceresit/Cimsec CL58 Multiverlegeplatte Ardex DS 40 PCI (BASF) Polysilent Unifloor Heat-Foil/Redupax/Redupax+	Ceresit/Cimsec CL58 Multiverlegeplatte PCI (BASF) Polysilent

3.6 Impact sound insulation

Particular attention should be paid to impact sound insulation. The impact sound improvement values should be determined by the planner or architect. The impact sound insulation must be matched to the corresponding floor structure as per Section 3. Materials that may be laid directly underneath the VarioComp floor heating to improve the impact sound insulation, see table chapter 3.5.

¹ Edge insulating strips are to be applied along the exterior walls, including columns, steps, door frames, pillars and shafts. They prevent sound and thermal bridges and allow the VarioComp floor heating to expand.

4 MOVEMENT JOINTS

Movement joints (e.g. with edge insulation strips) are attached to provide tension-free accommodation of length alterations. These are to be defined by the architect or planner.

- Max. section size 80 m², max. edge length 12 m
- Keep the number of pipe feed-throughs through the movement joints as small as possible

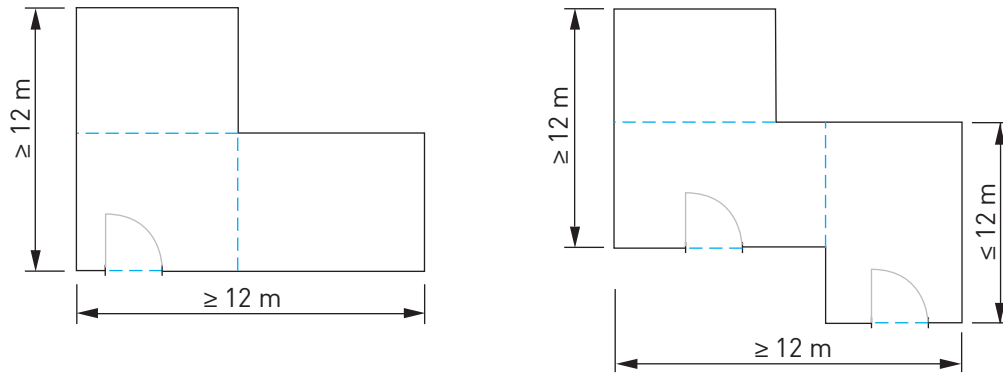

The movement joints are particularly significant in the case of ceramic coverings. It is crucial that the movement joints run congruently in all layers (VarioComp floor heating and floor covering).

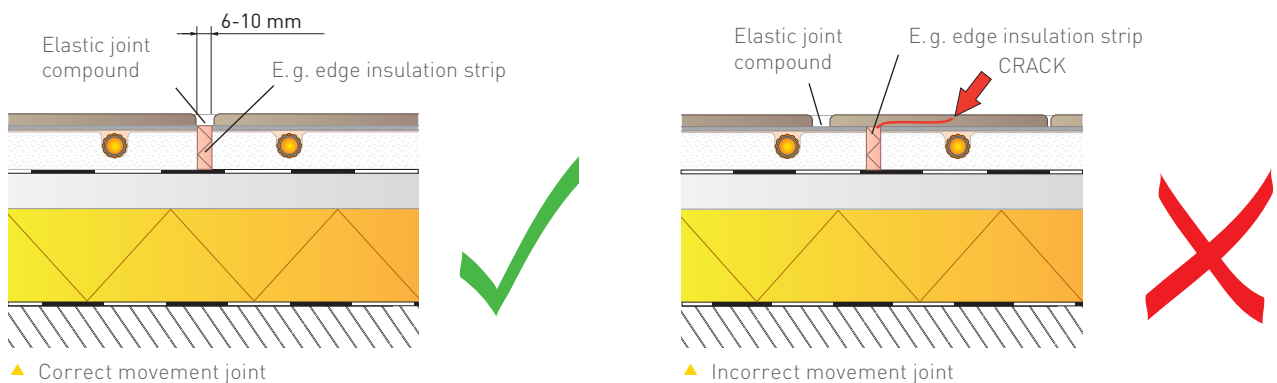

▲ Correct movement joint

▲ Incorrect movement joint

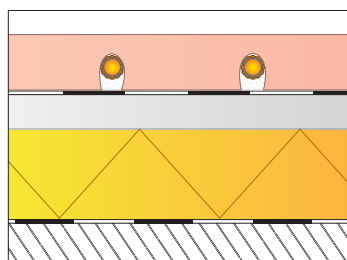

▲ Pipe feed-through through the movement joint (no sleeve tube required)

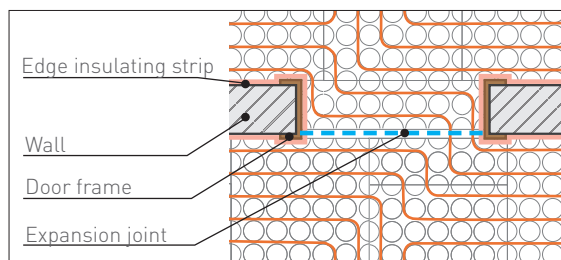

▲ In the vicinity of the door, the expansion joint is fed through under the door leaf.
Variant 1: Door area fitted with VarioComp panel

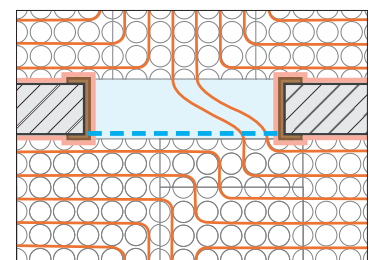

▲ Variant 2: Later, only use Vario-Comp filling compound to fill in the door area.

5.3 Heat output tables

Thermal resistance d/λ : 0.01 m²K/W

Caution! The flow temperature must never exceed 50 °C

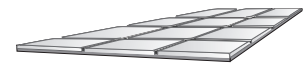

tiles, ceramic and natural stone coverings

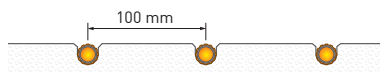

t_f/t_r [°C]	t_{mH} [°C]	Heat output [W/m ²] at room temperature...					T_0 [°C] (at $T_r = 20$ °C)
		... 15 °C	... 18 °C	... 20 °C	... 22 °C	... 24 °C	
30/20	25.0	55	39	27	16	-	23
30/25	27.5	69	53	41	30	19	24
35/25	30.0	83	67	55	44	33	25
35/28	31.5	92	75	64	53	41	26
35/30	32.5	97	81	69	58	47	26
37.5/32.5	35.0	111	94	83	72	61	28
40/30	35.0	111	94	83	72	61	28
40/35	37.5	125	108	97	86	75	29
45/35	40.0	139	122	111	100	89	30
45/40	42.5	153	136	125	114	103	32
50/40	45.0	167	150	139	128	117	33
50/45	47.5	181	164	153	142	131	34



Not recommended for living rooms or bare-foot areas!

t_f/t_r [°C]	t_{mH} [°C]	Heat output [W/m ²] at room temperature...					T_0 [°C] (at $T_r = 20$ °C)
		... 15 °C	... 18 °C	... 20 °C	... 22 °C	... 24 °C	
30/20	25.0	46	32	23	14	-	22
30/25	27.5	58	44	35	25	16	23
35/25	30.0	70	56	46	37	28	24
35/28	31.5	77	63	53	44	35	25
35/30	32.5	82	67	58	49	39	25
37.5/32.5	35.0	93	79	70	60	51	26
40/30	35.0	93	79	70	60	51	26
40/35	37.5	105	91	82	72	63	28
45/35	40.0	117	103	93	84	75	29
45/40	42.5	128	114	105	96	86	30
50/40	45.0	140	126	117	107	98	31
50/45	47.5	152	138	128	119	110	32

$$t_{mH} = \text{mean hot water temperature} = \frac{t_f + t_r}{2} \text{ [°C]}$$

T_r = room temperature [°C]

T_0 = mean surface temperature [°C]

t_f/t_r = flow temperature / return temperature [°C]

Thermal resistance d/λ : 0.075 m²K/W

Caution! The flow temperature must never exceed 50 °C

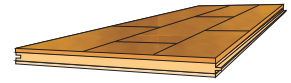

thin parquet floors,
laminates and carpets

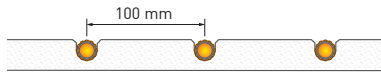

t_f/t_r [°C]	t_{mH} [°C]	Heat output [W/m ²] at room temperature...					T_o [°C] (at $T_r = 20$ °C)
		... 15 °C	... 18 °C	... 20 °C	... 22 °C	... 24 °C	
30/20	25.0	44	30	22	13	-	22
30/25	27.5	55	42	33	24	15	23
35/25	30.0	66	53	44	35	26	24
35/28	31.5	72	59	50	42	33	25
35/30	32.5	77	64	55	46	37	25
37.5/32.5	35.0	88	75	66	57	48	26
40/30	35.0	88	75	66	57	48	26
40/35	37.5	99	86	77	68	59	27
45/35	40.0	110	97	88	79	70	28
45/40	42.5	121	108	99	90	81	29
50/40	45.0	132	119	110	101	92	30
50/45	47.5	143	130	121	112	103	31



Not recommended for living rooms or bare-foot areas!

t_f/t_r [°C]	t_{mH} [°C]	Heat output [W/m ²] at room temperature...					T_o [°C] (at $T_r = 20$ °C)
		... 15 °C	... 18 °C	... 20 °C	... 22 °C	... 24 °C	
30/20	25.0	37	26	18	11	-	22
30/25	27.5	47	36	28	20	13	23
35/25	30.0	56	45	37	30	22	23
35/28	31.5	62	51	43	36	28	24
35/30	32.5	66	55	47	39	32	24
37.5/32.5	35.0	75	64	56	49	41	25
40/30	35.0	75	64	56	49	41	25
40/35	37.5	85	74	66	58	51	26
45/35	40.0	94	83	75	68	60	27
45/40	42.5	104	93	85	77	70	28
50/40	45.0	113	102	94	87	79	29
50/45	47.5	123	112	104	96	89	30

t_{mH} = mean hot water temperature = $\frac{t_f + t_r}{2}$ [°C]

T_o = mean surface temperature [°C]

T_r = room temperature [°C]

t_f/t_r = flow temperature / return temperature [°C]

HEAT OUTPUT for a floor covering with a thermal resistance¹ of $d/\lambda = 0.01 / 0.05 / 0.075 / 0.10 \text{ m}^2\text{K/W}$

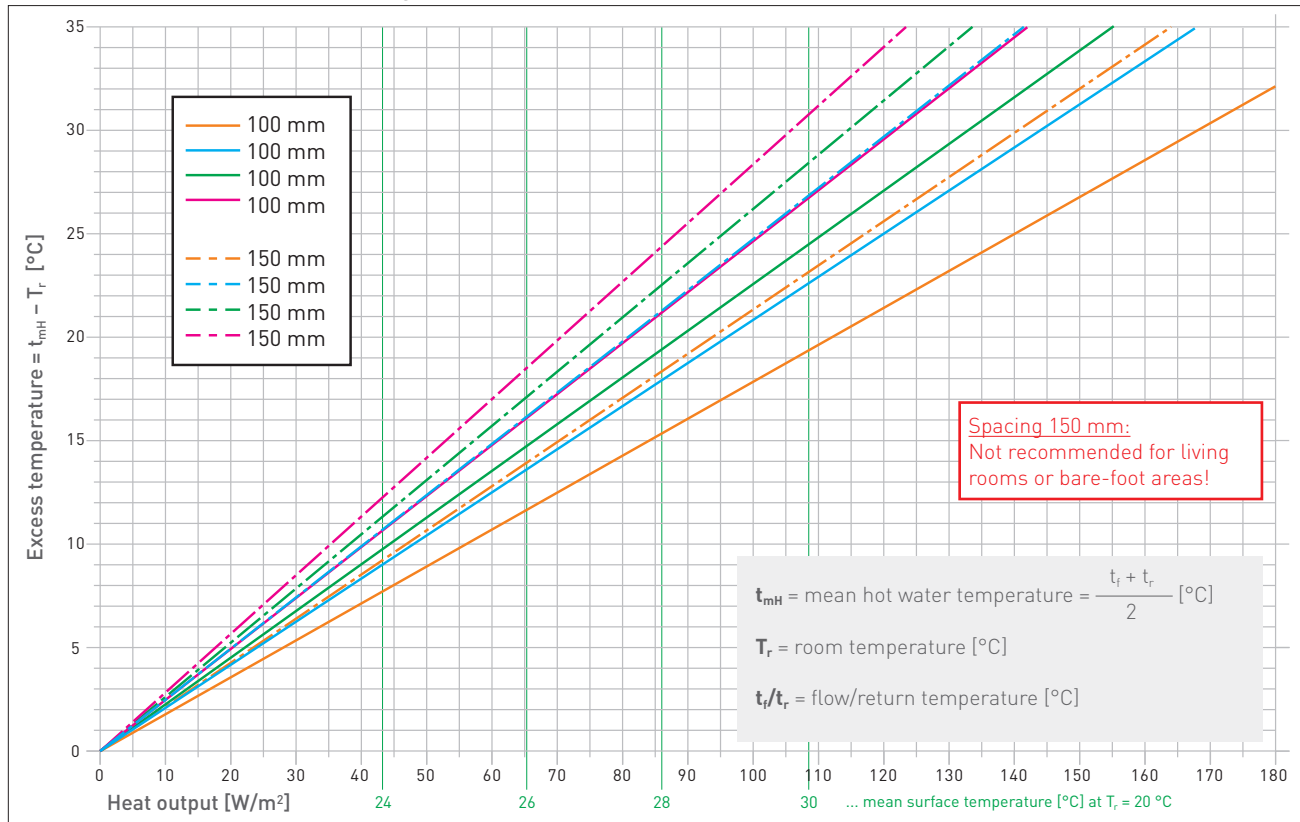

HEAT OUTPUT for a floor covering with a thermal resistance¹ of $d/\lambda = 0.12 / 0.14 / 0.16 / 0.18 \text{ m}^2\text{K/W}$

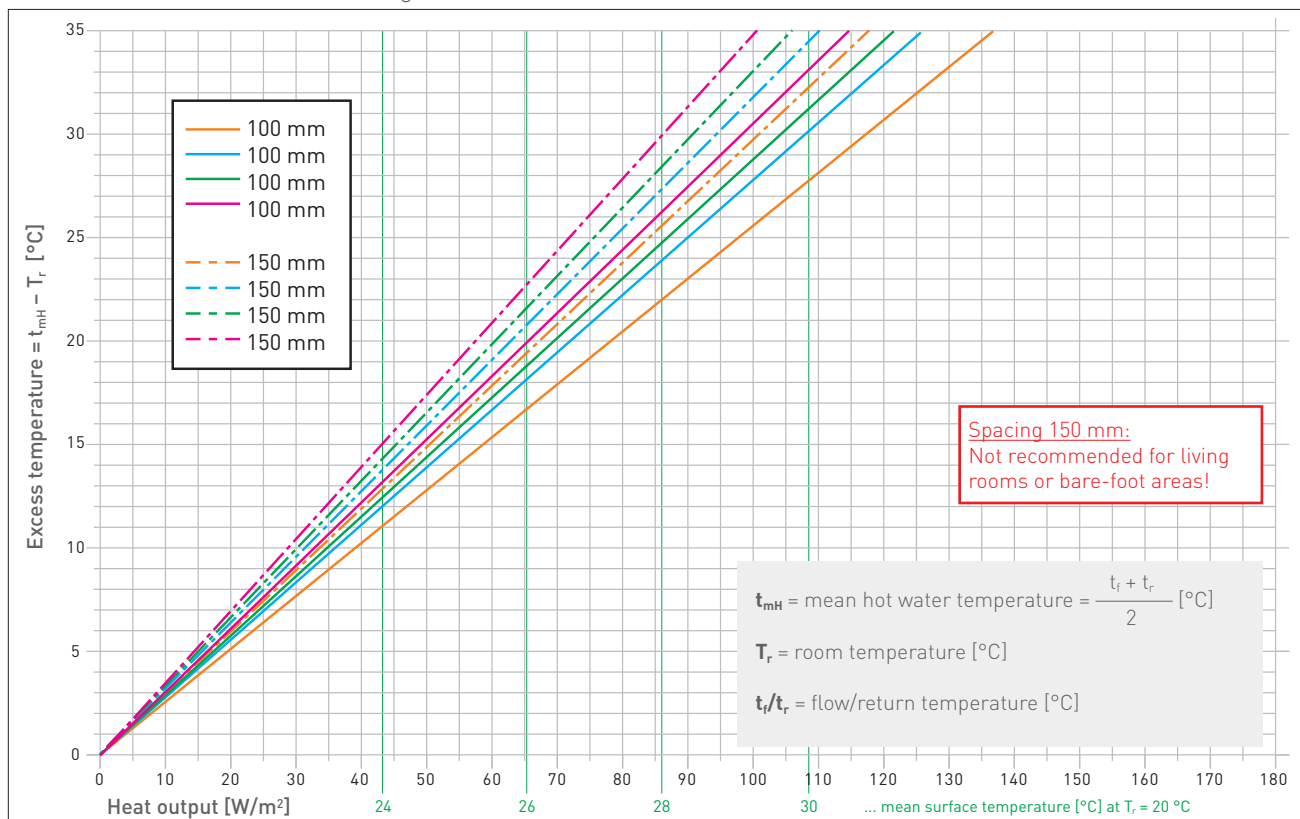

¹ Guidelines for the thermal resistance of various floor coverings see chapter 8.1

6 PIPING

The required thermal output of the individual room determines the spacing between the pipes:

- 100 mm: living rooms and barefoot areas to create a pleasant room atmosphere
- 150 mm: e. g. workshop, halls, office etc.

Maximum pipe length per heating circuit including supply pipe: 80 m

Pipe spacing	Pipe requirement
100 mm	10 m/m ²
150 mm	6.7 m/m ²

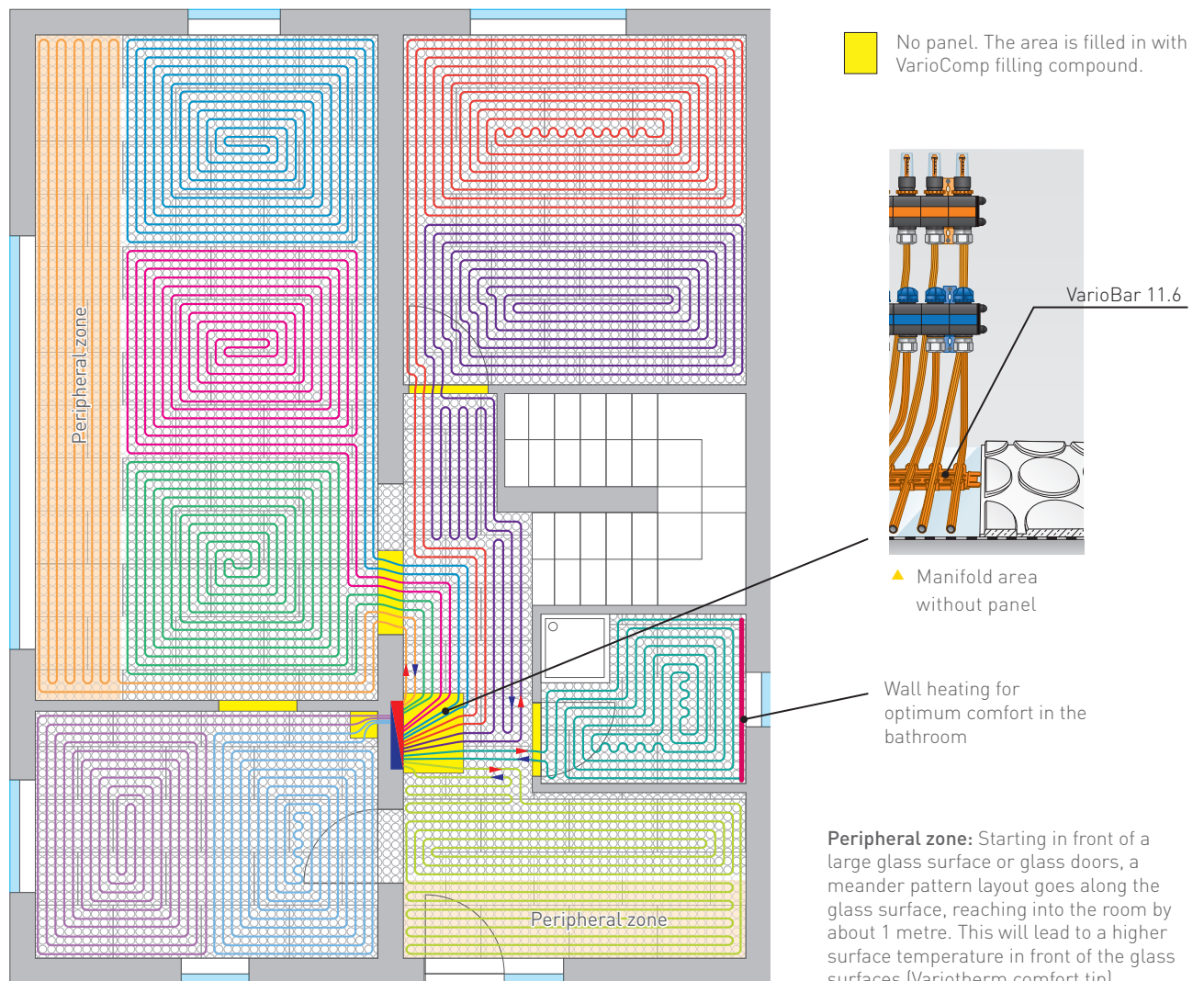
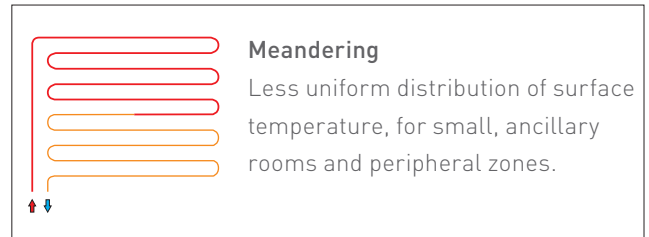
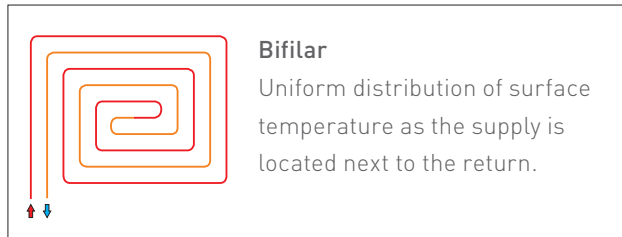

▲ Laying example of a single-family house with a constant pipe spacing of 100 mm

7 PRESSURE LOSS

Example: The total pressure loss Δp_{total} of a 7.2 m² VarioComp heating surface (one heating circuit) is to be calculated. The desired flow/return temperature is 37.5/32.5 °C, resulting in a heat output of 66 W/m² at a room temperature of 20 °C (thin parquet, $d/\lambda = 0.075 \text{ m}^2\text{K/W}$).

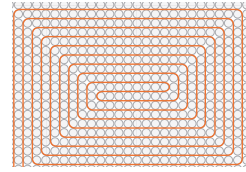

The total pressure loss Δp_{total} is calculated using the following components:

- VarioProFile pipe
- Heating/cooling distribution manifold
- Boiler house (mixing valve, boiler ...)

1. VarioProFile pipe 11.6x1.5

Calculation of the flow rate ω from the pressure loss diagram:
 $Q = 475.2 \text{ W}$ ($66 \text{ W/m}^2 \times 7.2 \text{ m}^2$)
 $\Delta T = 5 \text{ K}$ ($t_f/t_r = 37.5/32.5 \text{ °C}$)
 $\text{Flow volume } m = Q \div c \div \Delta T = 475.2 \text{ W} \div 1.163 \text{ Wh/kgK} \div 5 \text{ K} = 81.7 \text{ kg/h}$
 A flow volume $m = 81.7 \text{ kg/h}$ (= l/h) yields a flow rate $\omega = 0.4 \text{ m/s}$

Pipe length for 7.2 m ² heating surface:	
72 m (1 m ² = 10 m pipe at 100 mm pipe spacing)	
Press-fit coupling	Coefficient of resistance ζ (Zeta)
16 x 11.6	6.9
11.6 x 11.6	7.2
Density of water ρ (Rho)	1000 kg/m ³
Specific heat capacity of water c	1.163 Wh/kgK

- Δp for 7.2 m² VarioComp: $335 \text{ Pa/m} \times 72 \text{ m} = \underline{24\,120 \text{ Pa}}$ (pipe laid "endless")

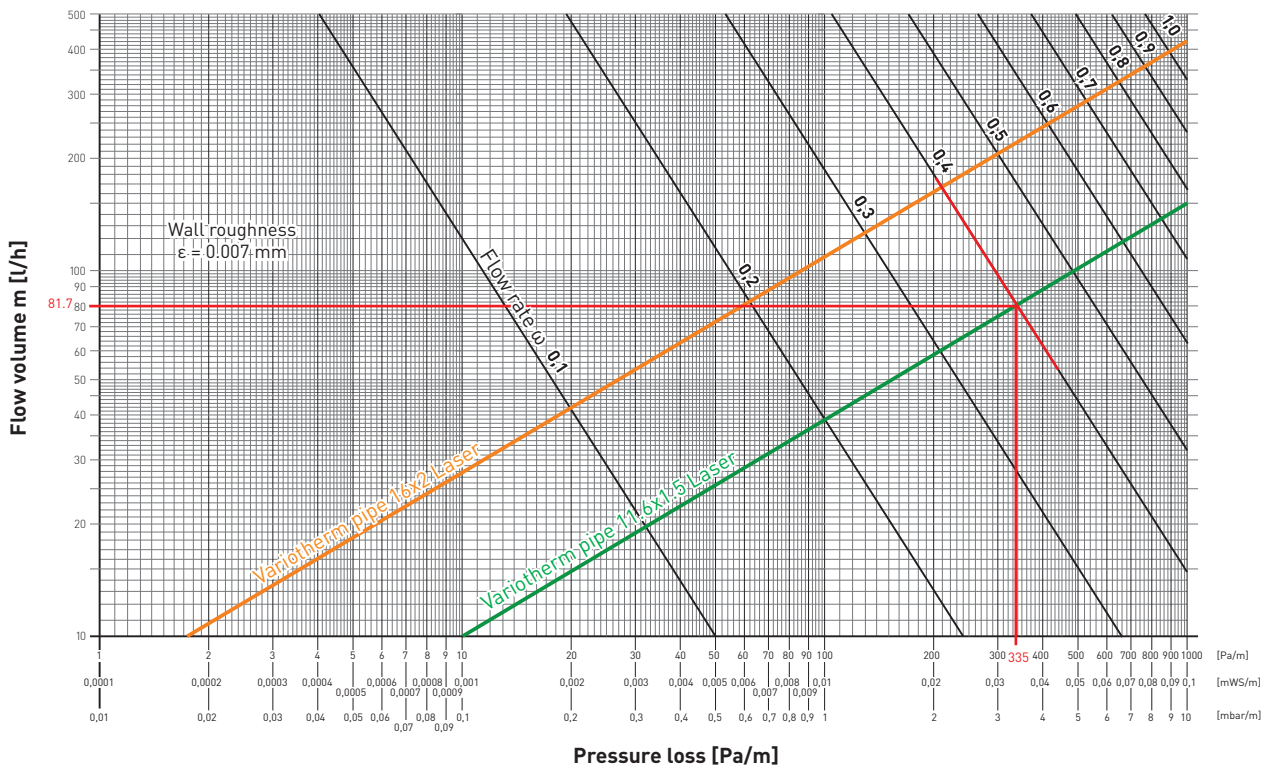

In case of setting a press-fit coupling for connecting residual lengths of pipe:

- Δp for press-fit coupling 11.6 x 11.6: $\zeta \times \rho/2 \times \omega^2 = 7.2 \times 500 \text{ kg/m}^3 \times (0.4 \text{ m/s})^2 = 576 \text{ Pa}$

2. Heating/cooling distribution manifold

The flow rate characteristic curves for calculating the pressure loss of the heating/cooling distribution manifold for the heating circuits in question.

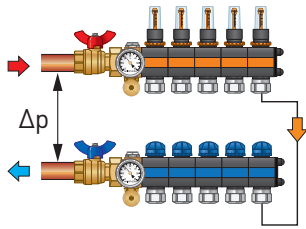

- Δp of the heating/cooling distribution manifold with an open valve up to 81.7 l/h = 900 Pa

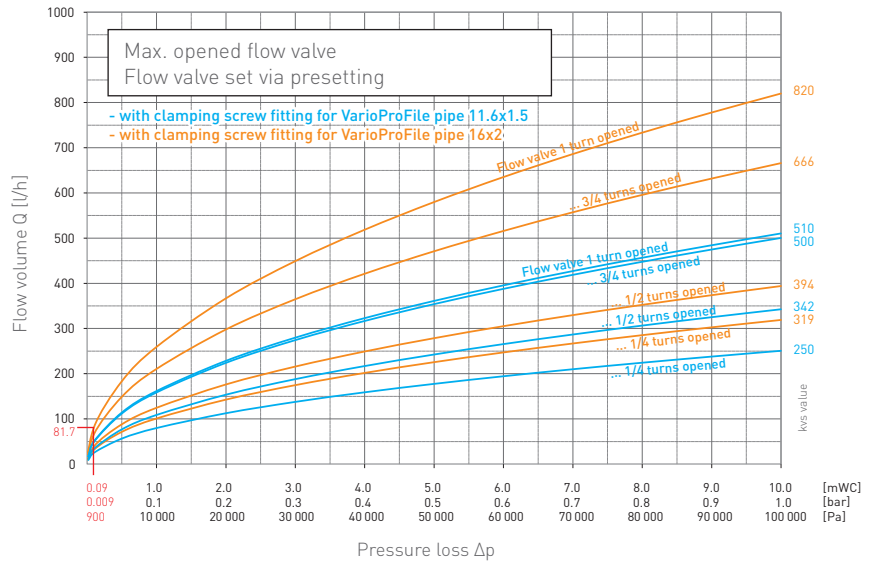

3. Boiler house (assumptions)

- Δp Mixing valve = 6000 Pa
- Δp Connection piping = 3500 Pa
- Δp Boiler = 3000 Pa

4. Total pressure

- $\Delta p_{\text{total}} = 24\,120 + 900 + 6000 + 3500 + 3000 = 37\,520 \text{ Pa} = 37\,520 \text{ Pa} = 3.75 \text{ mWC}$

5.) Selection of the heating circulation pump (example: Wilo Yonos PICO Plus 25/1-6)

At the calculated pressure loss of 3.75 mWS the pump supplies a maximum volume flow of 1.65 m³/h.

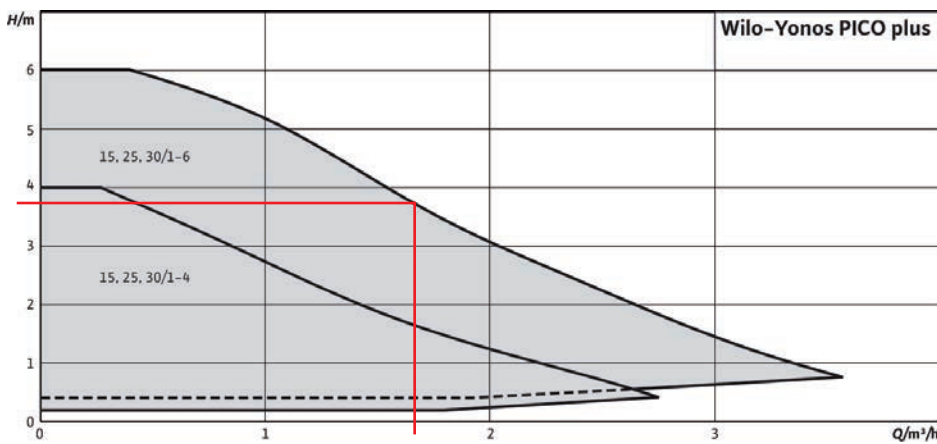

- ▲ Example: Wilo Yonos PICO Plus 25/1-6 heating circulation pump

8 FLOOR COVERING

8.1 General

- The floor covering used must be suitable for floor heating systems (observe the manufacturer's instructions).
- The surface of the VarioComp complies with ÖNORM DIN 18202 (Table 3 – limits for evenness deviations, Row 3):

Measuring point spacing	0.1 m
Pitch max.	2 mm

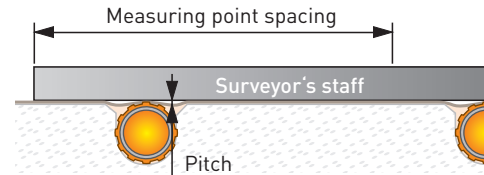

Floors should have a max. thermal resistance of 0.15 m²K/W.
 Variotherm recommends: ≤ 0.1 m²K/W (incl. underlay/adhesive)

Guidelines for the thermal resistance R [m²K/W] of various floor coverings:

Floor covering	Thickness	Thermal resistance R = d/λ [m ² K/W]
Tiles	8 mm	0.01
Clinker slabs	11 mm	0.01–0.02
Marble	10 mm	0.01
Natural stone slab	12 mm	0.01
Linoleum	2.5 mm	0.015
PVC coverings	2.5 mm	0.01–0.02
Cork parquet	4 mm	0.05
Prefinished parquet floor (2-layer)	10 mm	0.05–0.07
Prefinished parquet floor (3-layer)	14 mm	0.07–0.10
Laminate	9 mm	0.05
Thin carpet	6 mm	0.07–0.11
Medium-thick carpet	9 mm	0.11–0.15
Thick carpet	13 mm	0.15–0.24

Caution: The floor covering should be laid as quickly as possible to avoid any soiling of the filling compound surfaces or damage to the pipes.

8.2 Residual humidity of the VarioComp filling compound

Before laying the floor covering, the VarioComp filling compound must be dried in accordance with the following table:

Floor covering (Take note of the manufacturer's instructions!)	CM value (remove 100 g of filling compound for measuring)	Estimated drying time at t _i = 20 °C, max. 50 % relative humidity	
		without baking out	with baking out ¹ at t _i = 40 °C
Stone & ceramic coverings in a thin bed	1.3 %	6 days	24 h
Wood covering, parquet	0.3 %	8 days	36 h
Linoleum, PVC, vapour tight floor covering (the levelling mass has already been applied in accordance with Chapter 8.4)	0.3 %	not possible	≥ 48 h

¹ At t_i = 20 °C, you must wait at least 4 hours after finishing applying the filling compound before beginning the baking out process.

8.3 Borders between VarioComp panels and blank panels (at bonding of floor coverings)

Cover the borders using glass fibre cloth (4 × 4 mm) at an overlap of 200 mm (e.g. bond using tile adhesive).

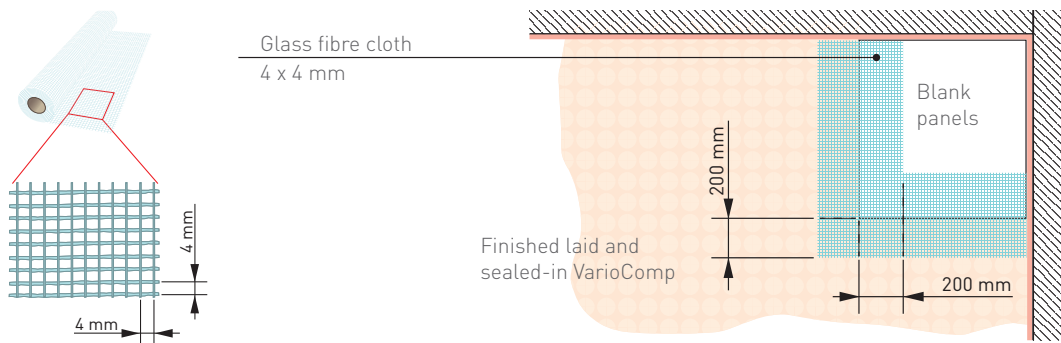

8.4 Levelling out with a calcium sulphate floor levelling compound

In the following cases, the finished VarioComp surface is additionally levelled with a calcium sulphate based floor levelling compound:

- For soft floor coverings and synthetic resin floors (see chapter 8.7)
- Depressions which exceed the standard tolerances (see chapter 8.1) or which are too high for the floor covering according to the floor installer

Brand	Primer	Calcium sulphate floor-levelling compound
Mapei	Primer G	Planitex D10 (Turbo)
Schönox	Schönox VD, VD Fix	Schönox APF
Maxit	maxit floor 4716	maxit floor 4095
Fermacell	Deep primer	Self-levelling compound
Thomsit	R766, R777	AS1, AS2
Stauf	D54	GS
Baumit	Grund	Nivello Quattro
Ardex	Ardex P51	Ardex K22
Wakol	D 3040	A 830
Smet	Casea casuprim HB	Casea casufloor FS
Ball	Stopgap 1100 Gypsum	Stopgap P121
Uzin	Suitable primer from Uzin product range	NC 105 / NC 110 / NC 112 Turbo

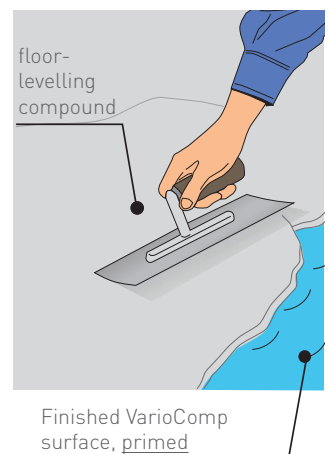

8.5 Compound sealing in rooms exposed to high humidity

For surfaces which are exposed to high levels of humidity, sealing systems must be applied (e.g. bathrooms with shower trays - W3).

The wall construction must be sealed using sealing system and additional sealing tape.

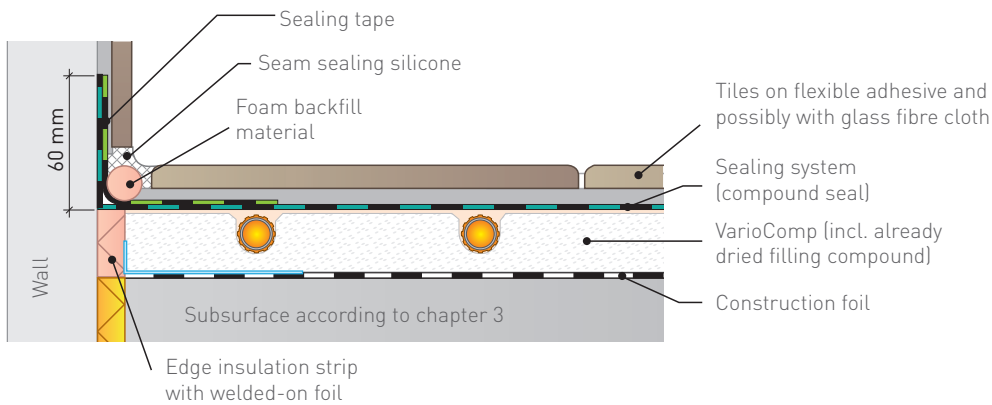

<< Example:
Tiled floor covering subject to the effects of moisture (W2/W3) [More details for tiled covering on VarioComp see chapter 8.6]

Use of primer and sealing system (compound sealing):

Operational demands group ÖN B 3407	ZDB composite waterproofing (Germany)	Which room?	Adhesive mortar with tile coverings	Primer	Sealing system
W1	-	Residential sector: living rooms, corridors, toilets, offices and the like	Calcium sulphate flexible adhesive mortar	Not required	Not required
			Cement flexible adhesive mortar	Required	Not required
W2	-	Residential sector: kitchen and rooms with similar usage Commercial sector: toilet systems	Only cement flexible adhesive mortar	In addition to the sealing system, when recommended by the manufacturer	Recommended
W3	A0	Wall and floor surfaces without drainage (e.g. bathroom with shower tub higher than 20 mm above floor covering), toilet systems without floor drainage, porch	Only cement flexible adhesive mortar	In addition to the sealing system, when recommended by the manufacturer	Required
W4-W6	B0, A, B, C	Wall and floor surfaces with drainage (e.g. shower with flush drain at the same level as the floor), swimming bath area, shower systems, industrial kitchen, balconies, terraces ...	No VarioComp floor heating possible.		

Product examples for primer or sealing system (compound sealing):

Manufacturer / Brand	Primer	Sealing system
Ardex	Ardex P51	Ardex 8 + 9
Cimsec	Gipsgrundierung / Haftbrücke	Dichtflex CL51 / 2K Abdichtung CL49
PCI (BASF)	Gisogrund	Lastogum
Schönox	Schönox KH	Schönox HA / 1K DS Premium
Mapei	Primer G	Mapegum WPS
Weber	weber.prim 801	weber.tec 822
Ceresit	Tiefgrund lösemittelfrei	Abdichtung Dusche und Bad
Sopro ¹	GD 749	Flächendicht flexibel FDF 525/527

¹ For more details, see the Sopro installation recommendations (available on request).

8.6 Stone and ceramic coverings

See also the appropriate standards for laying tiles, panels and mosaics.

- The surface must be dust-free.
- Sealing systems must be used on surfaces subject to the effects of moisture (see chapter 8.5).
The wall boundaries must be sealed using appropriate sealing tape.
- A flexible adhesive (S1 classified according to EN 12004) is used to bond the tiles. A primer must be applied if required by the adhesive manufacturer. This is particularly the case for flexible cement adhesives.
- Flexible grouting mortar must be used for grouting.
- After laying the tiles, boundaries with the walls are additionally sealed with silicone.

For critical floor structures, we recommend integrating a 4×4 mm fibre glass cloth into the flexible adhesive.

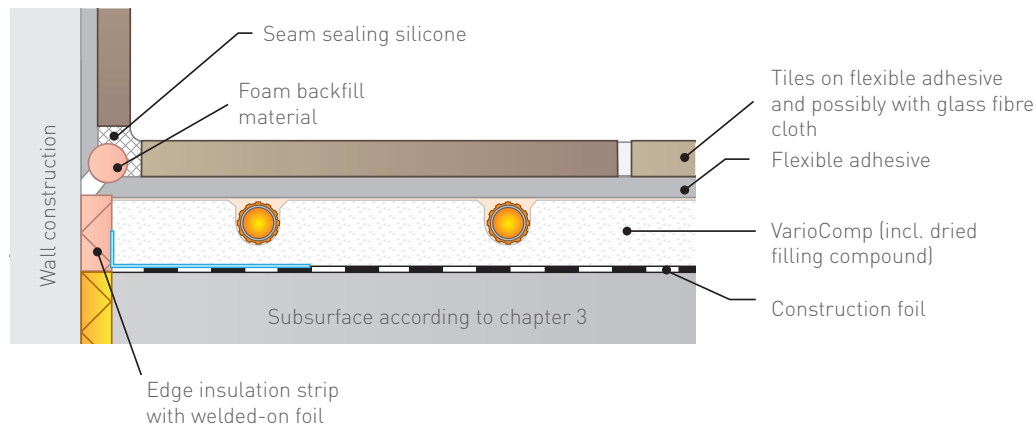

8.7 Linoleum, carpet, PVC floor covering and synthetic resin floors

For soft floor coverings and synthetic resin floors, a calcium sulphate-based floor-levelling compound (provided by customer) at least 4 mm thick is laid over the completed VarioComp (see chapter 8.4).

Caution: Only use synthetic resin floors with low thickening tension (polyurethane-based)!

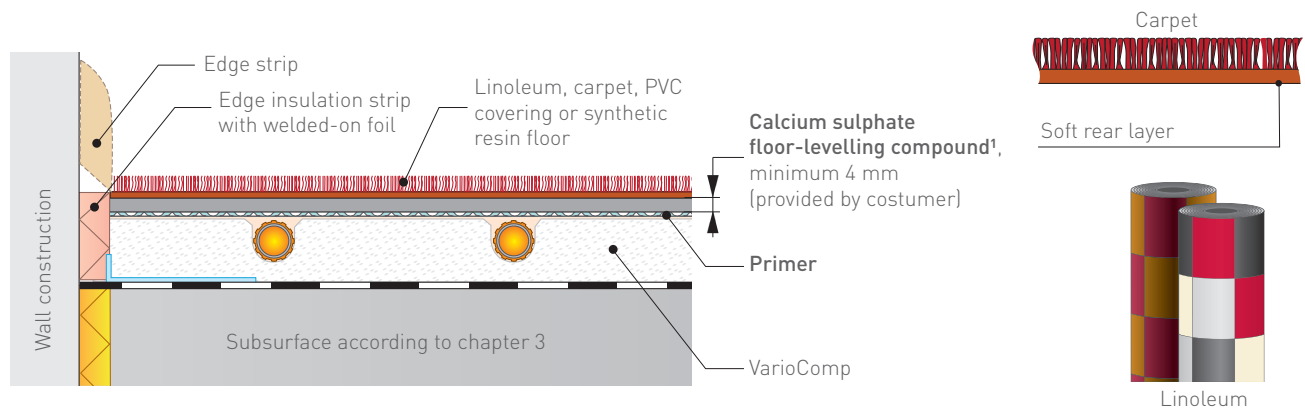

¹ Please observe the relevant manufacturer's instructions for the required primer or sealant of the VarioComp surface and of the planned floor-levelling compound. Product examples see chapter 8.4.

Work cannot be started earlier than 48 hours after applying the VarioComp filling compound.

8.8 Wood covering, parquet and laminate

- **It is not necessary and prohibited to abrade the surface of the finished VarioComp!**
- Lay only floor coverings that are approved by the manufacturer for use with floor heating systems.
- Floors should have a max. thermal resistance of 0.15 m²K/W.
Variotherm recommends: ≤ 0.1 m²K/W (incl. underlay/adhesive)
- The differences in thermal output between the glued and floating design are negligible. Both versions have approximately the same surface temperatures.

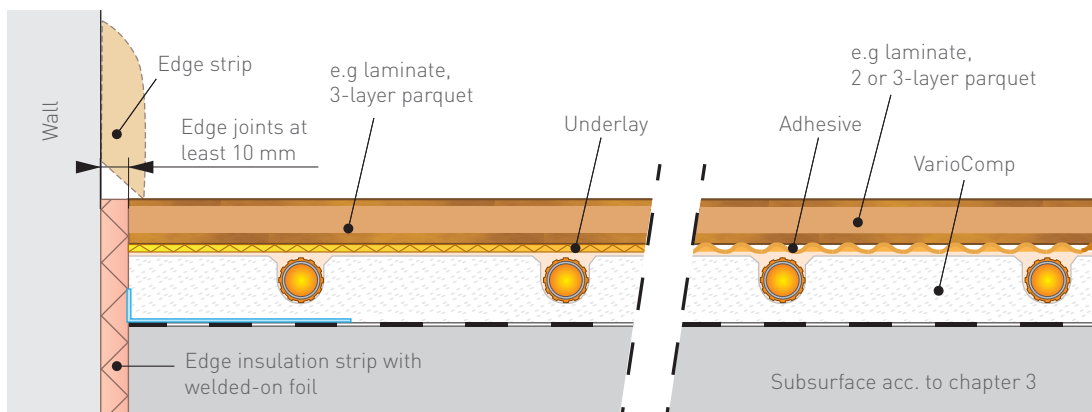

FLOATING DESIGN (recommended by Variotherm):

- The laminate or 3-layer parquet covering is laid floating on an underlay suitable for floor heating (max. 2 mm).
- The edge seam to adjacent components should be at least 10 mm.

Advantages: Cover easy to replace - no risk that the VarioComp will be damaged during dismantling.
Costs of laying usually lower.

Disadvantages: Potential joint formation due to material expansion. Steps may be heard.
Sanding the parquet may be problematic (springing of the cover).

ADHESIVE PARQUET:

Parquet can be directly adhered to the VarioComp under the following conditions:

- 2 or 3-layer parquet suitable for floor heating, without gluing the tongue and grooves.

No adhesion of solid wood floors is permitted!

- Maximum flow temperature 40 °C (maximum temperature limiter required!)
- Adhesion without primer, with e.g.:
 - Mapei Ultrabond P990 1K
 - Thomsit P 695
 - Ardex Premium AF 480 MS
 - Weitzer Parkett Profi-SMP adhesive no. 400-EC1
 - Sika SikaBond-52 Parquet and SikaBond-54 Parquet

or equivalent adhesive (primer as per manufacturer's specifications).

Advantages: Almost no joint formation.

Disadvantages: Costs of laying usually higher.

Parquet difficult to replace - VarioComp could be damaged during dismantling.

ENJOY THE COMFORT & SAVE ENERGY

That's why our customers love us:

Heating and cooling optimised for COMFORT in all rooms!

Fast and friendly service, ANSWERS backed up with expertise!

Always in tune with the latest technology, INNOVATION guaranteed!

Everything CLEAR and SIMPLE, in writing of course!

PROFESSIONALISM at all times, from the first contact to the reference list!

VARIOTHERM SINCE 1979

Variotherm is an Austrian model plant with hundreds of partners in Austria, Europe and around the world.

All rights pertaining to distribution and translation, in whole or in part, including film, radio, television, video recording, Internet, photocopying and reprinting, are reserved. Subject to mistakes and printing errors. Misprints and errors excepted.



Austria's
Leading
Companies
2014



MFH

VARIOTHERM HEIZSYSTEME GMBH

GÜNSELSDORFER STRASSE 3A

2544 LEOBERSDORF

AUSTRIA

Phone: 0043 22 56 - 648 70-0

Fax: 0043 22 56 - 648 70-9

office@variotherm.com www.variotherm.com