

MCCH PLANNING

MODULAR CEILING COOLING. MODULAR CEILING HEATING.

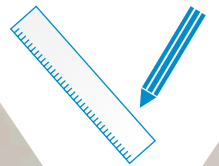

35/30 °C
68 W/m²

16/20 °C
60 W/m²



ModuleCeiling.
Classic and Acoustic.

www.variotherm.com

TABLE OF CONTENTS

1	PRINCIPLES	4
1.1	Cooling	4
1.2	Heating	5
1.3	Energy savings	6
1.4	Adapts to suit your home	6
1.5	Description and advantages of the ModuleCeiling	7
2	COMPONENTS	8
2.1	Overview	8
2.2	ModulePanels	10
2.3	Variomodular pipe 11.6x1.5 Laser	12
3	FIRE PROTECTION	13
4	SUBSTRUCTURE	14
4.1	Dimensions in border area	14
4.2	Main joists/main profiles	14
4.3	Cross joists/cross profiles	15
4.4	Directly fastened cross joists (variant without main joists)	16
4.5	Movement joints	16
4.6	Residual areas and panel transitions	17
5	COOLING/THERMAL PERFORMANCE	18
5.1	Calculation of the cooling and heating load	18
5.2	Variotherm dimensioning softwares	18
5.3	Cooling performance	19
5.4	Heat output tables	19
6	PIPING	20
7	ARRANGEMENT OF THE SURFACES	21
8	PRESSURE LOSS	22
9	FINISHED SURFACE	24
9.1	Stopping	24
9.2	Painting	24
9.3	Fastening loads to the ModuleCeiling	24
10	ACOUSTIC	25
10.1	General	25
10.2	Panel variants	25
10.3	Acoustic values	26
10.4	Reverberation time calculator (German only)	29

1 PRINCIPLES

Comfortably heated rooms provide a pleasant and healthy room climate in recreation rooms. Thermal insulation and shadowing are usually insufficient for achieving this level of well-being in rooms in summer. The Variotherm ModuleCeiling is an ideal enhancement to the room cooling: The rooms are pleasantly cooled in summer and heated in winter to an even temperature.

1.1 Cooling

Comfort is not only created through a particular air temperature in the room. The temperature of the surfaces enclosing the room is of equal importance. The perceived temperature is roughly consistent with the arithmetic mean of both temperatures.

What makes people feel comfortable?

People feel comfortable when the following basic "thermal comfort" equation holds:

$$\text{Heat production} = \text{heat loss}$$

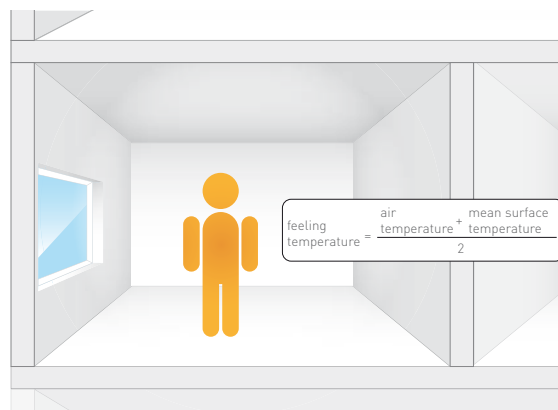

▲ Impact of the room on felt temperature

Cooling via ceiling surfaces offers the advantage of gentle radiation exchange between the cooled ceiling surface and the human body. Other warmer objects in this room (floor, interior walls, furnishings etc.) also radiate heat to this cooled surface, since thermal radiation always flows from the warmer to the colder object. This loss of heat reduces the surface temperature of these objects, thus providing a cooling effect. The ambient air in the room is also cooled to a comfortable level.

The ModuleCeiling does not generate uncomfortable forced air or noise, which are often regarded as annoying properties of conventional air-conditioning systems.

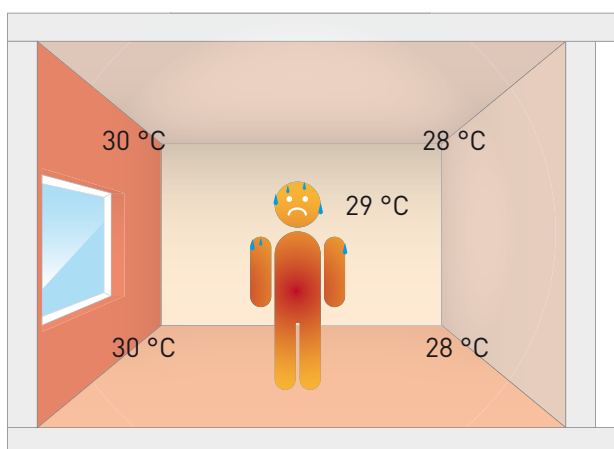

▲ Discomfort without cooling

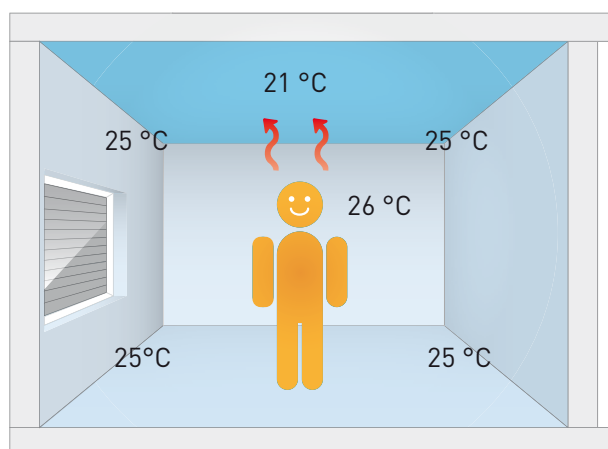

▲ Comfort with cooling

Based on experience, cooling makes sense at a room temperature ≥ 26 °C. To achieve a noticeable effect and suitably cool the body, a reduction of the ceiling surface temperature to approx. 19 - 22 °C is possible.

Economy

The necessary cooling performance can be better distributed with water than with air. The pumping costs for surface cooling systems are usually significantly lower than the costs incurred by using fans. A 100 percent coverage of the cooling load, as per VDI 2078 (calculation of the cooling load for air-conditioned rooms), is possible in buildings designed for low energy consumption with shadowing equipment and low internal loads.

One of the major advantages of ceiling cooling/heating systems is the low additional investment costs. A single system is used for the cooling and heating modes: the same ceiling surface, same piping system and the same heating/cooling distribution manifold with supply lines and circulation pump. The generation of cooling (chiller/heat pump/cooling from the floor and ground water) is planned in parallel to the heating unit. Many modern heat pumps already allow switching from heating to cooling mode – without major extra costs. Ambient sources of cooling (deep boreholes, ground collectors, wells...) can also be used – at zero cost.

Combination of displacement ventilation and surface cooling

Surface cooling does not replace an air-conditioning system with regard to dehumidification and ventilation. Displacement ventilation is an air-conditioning system with low air exhaust speeds and laminar flow of the escaping air at the exhaust vents. Low turbulence in the air flow through the room is achieved through the type of ducting in the room, blowing of air at floor level at a slightly subnormal temperature and extraction of the exhaust air at the ceiling level. This type of displacement flow, known as “displacement ventilation” can achieve almost complete freedom from draughts. The combination of ceiling cooling and displacement ventilation allows significantly higher cooling performance to be achieved compared to using only a displacement ventilation system, without exceeding thermally comfortable air speeds. If the supplied air is dehumidified then low ceiling surface temperatures, and thus high radiant cooling performance, can be achieved without the formation of condensation, even on hot and humid days.

1.2 Heating

The ModuleCeiling is not only suitable for cooling but is also perfectly suitable for heating when used in the correct manner.

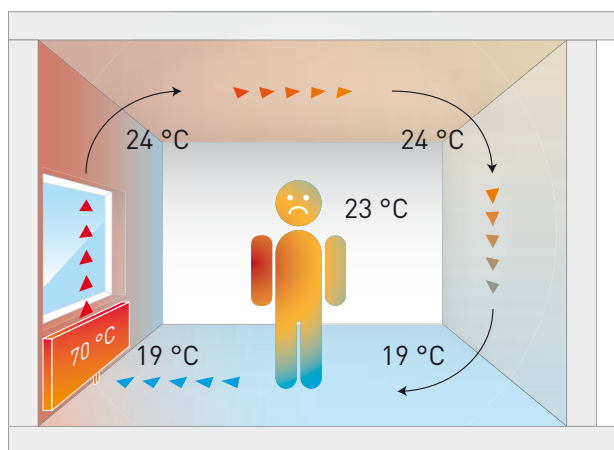

▲ Discomfort with radiators

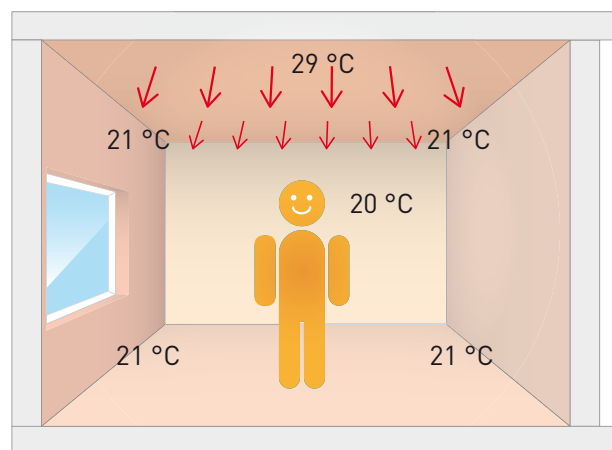

▲ Comfort with ceiling heating

The ModuleCeiling significantly increases the level of comfort compared to other heating systems. A lower room temperature can be chosen in comparison to convection heating because the radiant heat is perceived as warmer by people in the room.

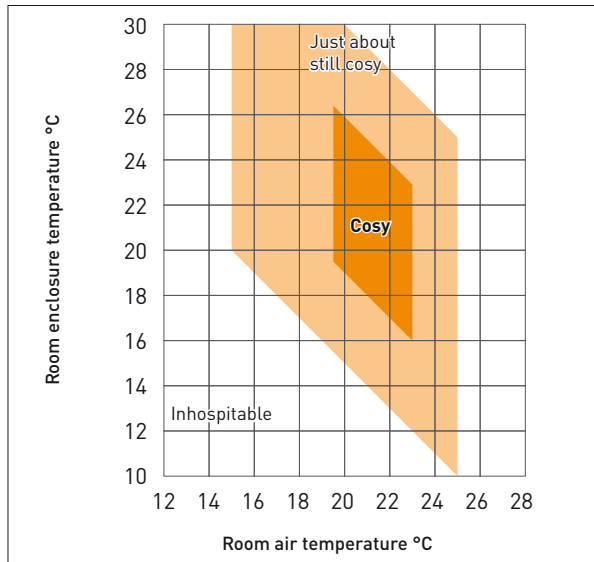

▲ Zone of cosiness

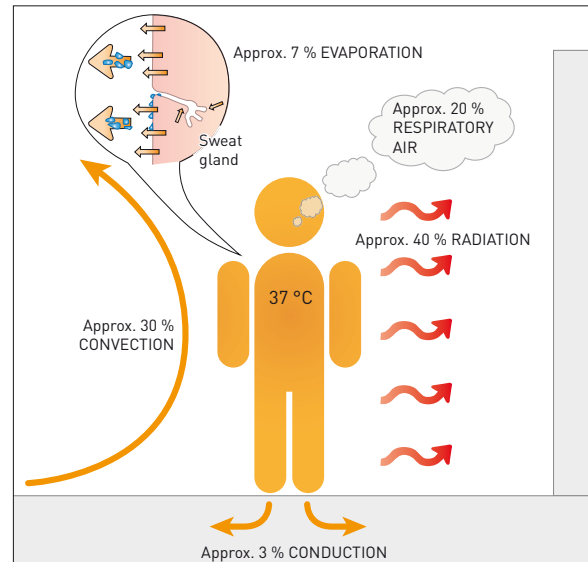

▲ Human heat balance

An important aspect of heat output from the human body is that this should occur as evenly as possible from all sides. We feel uncomfortable if too much heat is lost in one particular direction (e.g. cold surfaces, forced air) or the heat output is prevented in one direction (hot surfaces or vapour-tight, thick clothing). The lower the inside air temperature is, the warmer the surrounding surfaces (wall surfaces, floor and ceiling, as well as doors and windows) must be to ensure cosiness.

1.3 Energy savings

Energy losses are significantly reduced through an optimised ambient air temperature in conjunction with increased comfort. Heating cost savings of approx. 6 % per 1 °C reduced room temperature when heating or per 1 °C increased room temperature when cooling can be expected. This has the additional great physiological advantage of increasing the absorption of oxygen in the body of most people.

The ModuleCeiling system is ideal for use with low-temperature energy sources such as condensing boilers, heat pumps and solar collectors because it operates with low surface and heating medium temperatures. With the Variotherm ModuleCeiling you can achieve energy savings of up to 30 % compared to conventional heating systems.

1.4 Adapts to suit your home

The invisible cooling/heating ceiling eliminates the need for planning the installation of radiators and splitting devices. This saves a great deal of space and allows more freedom in designing the room layout: no restrictions in the wall and window designs or the interior architecture. Only the positions of the ceiling lights and spots need to be taken into consideration.

1.5 Description and advantages of the ModuleCeiling

The Variotherm ModuleCeiling is an extremely energy efficient cooling and heating system. As a flexible panel system, it is pre-assembled for installation in ceilings and pitched ceilings. Here, heating, cooling and complete ceiling are perfectly combined in a single product. The desired room temperature is achieved by using hot and cold water circulation to make sure you feel completely comfortable all year round.

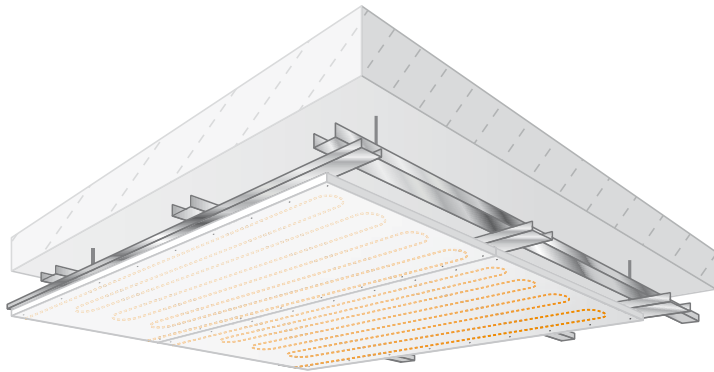

ModuleCeiling-Classic
for screwed ceilings
10 different panel types,
fire protection assessment

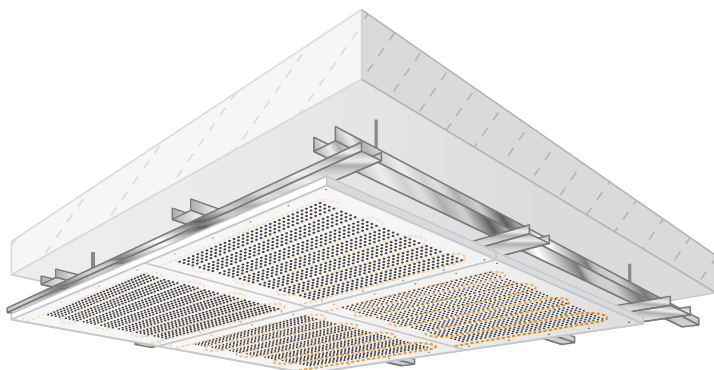

ModuleCeiling-Acoustic
for screwed ceilings
ModulePanels with a sound-absorbent
surface

The advantages:

- Cooling, heating and finished ceiling in one
- With acoustic functionality if desired: With Variotherm, the holes of the acoustic panels are not covered by cooling/heating elements! This is the only way to ensure certified, guaranteed noise reduction.
- Ideal for timber-framed buildings, pre-fabricated houses, attics and renovation
- Cooling system: silent, no forced air, energy-efficient
- Heating system: large-surface, extremely energy-saving low temperature system
- Totally flexible panel system for all construction requirements
- Gypsum fibre boards and components tested for their healthy building properties
- Fire protection assessment for ModuleCeiling-Classic (IBS Linz)



2 COMPONENTS

2.1 Overview

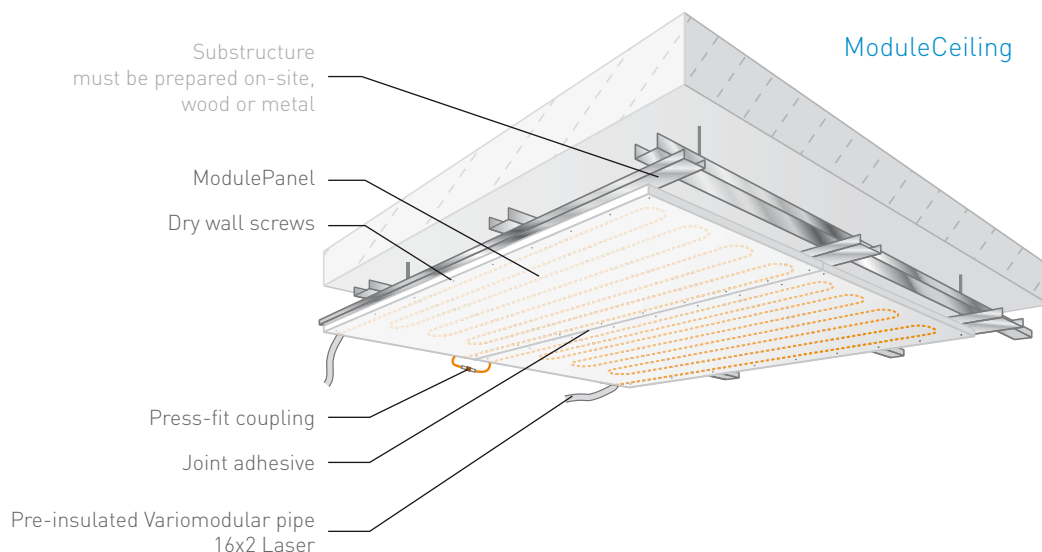

Greenline joint adhesive

PG 021

for connecting the blunt adjoining modular panels.
1 cartridge (310 ml) sufficient for 7 m².

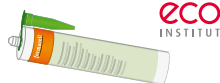

Part No.	PKU	Weight/PKU	Carton
F111	1 cartridge	550 g	25 cartridges

Dry wall screws 3.9 x 40 mm

PG 021

for joining modular panels to wooden/metal structures, optimum shank length, incl. associated bit.
Consumption: 16 pcs./m²

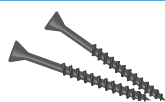

Part No.	PKU	Weight/PKU
F120-0250	Carton at 250 pcs.	0.6 kg
F120-1000	Carton at 1000 pcs.	2.4 kg

Duo adhesive

PG 021

for subsequent adhesion of ModulePanels. Breadth of assembly joints from 3 to 8 mm. 1 cartridge is sufficient for an approx. 7 m joint (with a breadth of 4 mm and a height of 18 mm). For each cartridge, we recommend 3 pieces of static mixing tube (F116). Caution: Special W048 manual applicator required!



Part No.	PKU	Weight/PKU	Carton
F115	1 cartridge	1 kg	10 pcs.
F116	1 static mixing tube	15 g	75 pcs.

Pre-insulated 16x2 Variomodular pipe Laser

PG 130

- Aluminium multi-layer composite pipe 16x2 Laser (PE-RT/AL/PE-RT)
- No oxygen diffusion whatsoever
- 95 °C, 10 bar
- Insulation: Polyethylene soft foam
Fire resistance as per EN 14313: CL-s1,d0

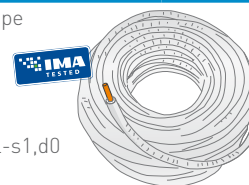

Part No.	Insulation thickness	PKU	Weight/PKU
V1226	6 mm	100 m roll	14.0 kg
V1227	9 mm	100 m roll	14.9 kg

Adhesive tape

PG 031

As a separating layer to joint surfaces or between the panel contact points and the substructure, if required. Roll: 50 mm x 66 m



Part No.	PKU	Weight/PKU	Carton
V288	1 pce.	210 g	36 pcs.

Duo manual applicator

PG 140

The matching manual applicator for applying the Duo adhesive.



Part No.	PKU	Weight/PKU
W048	1 pce.	1.4 kg
W050 (loan)	1 pce.	1.4 kg

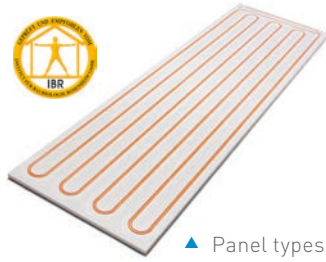

▲ Panel types see chapter 2.2

Panel characteristics:

Panel: gypsum fibreboard which has been tested for their healthy building properties

Fire resistance as per DIN EN 13501-1:

non-flammable, A2

Identification as per DIN EN 15283-2: GF-I-W2-C1

Thermal conductivity λ : 0.32 W/mK

Apparent density ρ_K : 1150 \pm 50 kg/m³

Water vapour diffusion resistance factor μ : 13

ModulePanel-Classic

- 18 mm thick gypsum fibreboard which has been tested for their healthy building properties
- With pre-installed Variomodular pipe 11.6x1.5 Laser at a grid size of 75 mm
- Marking of the screwing points (fastening area) on the front side

ModulePanel-Acoustic

The same properties as the "Classic" panel, but additionally with:

- Different sized holes to improve the acoustic characteristics
- Acoustic fleece on the rear side

Note:

The relative humidity must not exceed 70 % during storage, installation and additional processing of the ModulePanels and during the construction phase and normal use of the building. Wet plaster and wet screed must be applied and have dried before installation of the ModulePanels. The ModulePanels can be used in rooms up to moisture class W3 (ÖNORM B 3407). They are not approved for installation from moisture class W4 (e.g. canteens and shower blocks) upwards.

Press-fit couplings

PG 100

TH press-fit contour, incl. galvanic isolation, visual monitoring of insertion depth, tested as per EN 21003

Part No.	Type	Press-fitting jaws	PKU	Weight/PKU
Z1320	16 x 16	TH16	1 pce.	50 g
Z1610	16 x 11,6	TH16 & TH11.6	1 pce.	45 g
Z1600	11.6 x 11.6	TH11.6	1 pce.	30 g

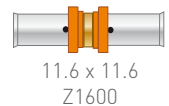
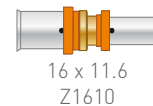
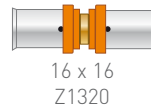

Press-fit brackets 90°

PG 100

TH press-fit contour, incl. galvanic isolation, visual monitoring of insertion depth, tested as per EN 21003

Part No.	Type	Press-fitting jaws	PKU	Weight/PKU
Z1370	16 x 16	TH16	1 pce.	50 g
Z1620	16 x 11,6	TH16 & TH11.6	1 pce.	45 g
Z1630	11.6 x 11.6	TH11.6	1 pce.	45 g

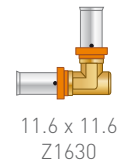
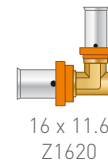
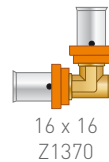

Cold shrink tape

PG 100

For optimum corrosion resistance of press-fit coupling connections as per ÖN H 5155. Roll: 50 mm x 15 m, 1 roll is sufficient for approx. 35 press-fit coupling connections (with a 50 % overlap).



Part No.	PKU	Weight/PKU	Carton
Z1699	1 pce.	990 g	20 pcs.

2.2 ModulePanels

CLASSIC

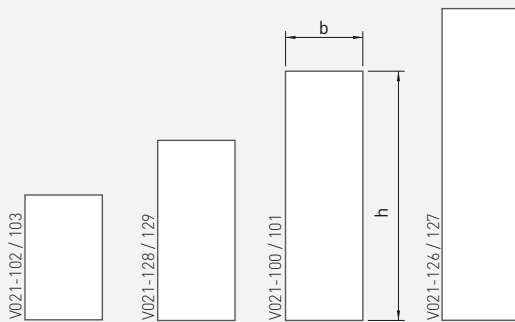
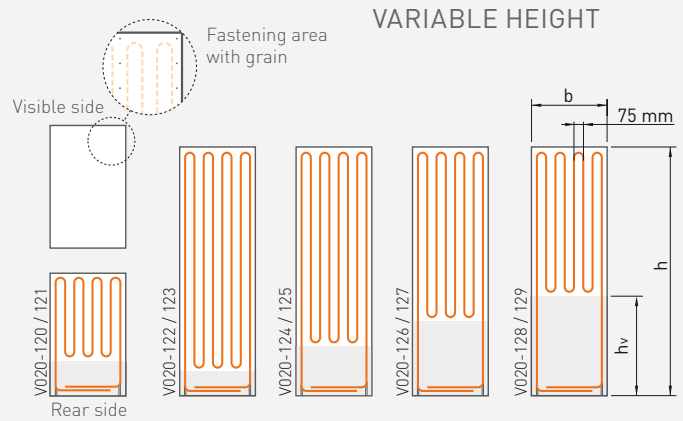
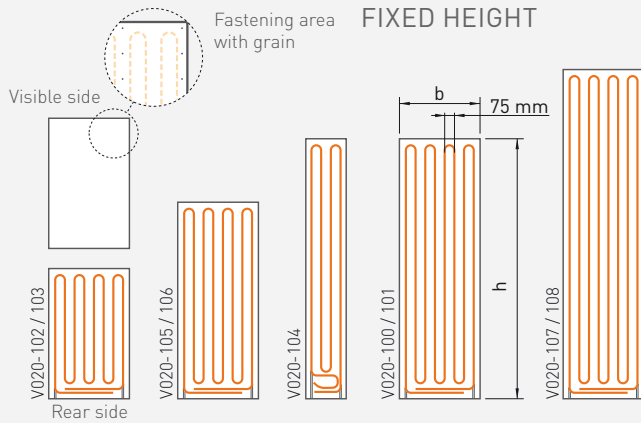

Fixed height panels:

The entire surface of the ModulePanel serves as a heating/cooling area.

Variable height panels:

Only part of the panel surface is used as a heating/cooling area, the unused area (grey) can be individually cut to size or used as a cutout region for recessed lighting.

ModuleExpansionPanels

ACOUSTIC

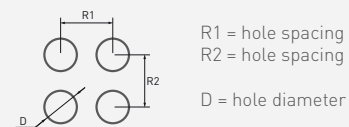
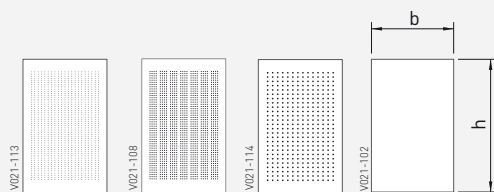
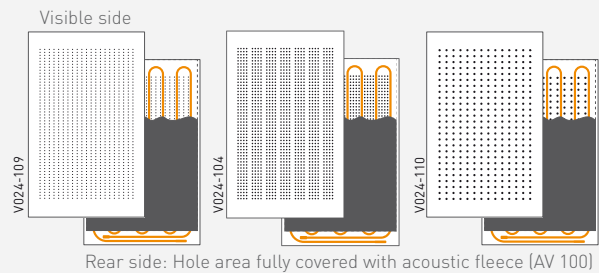
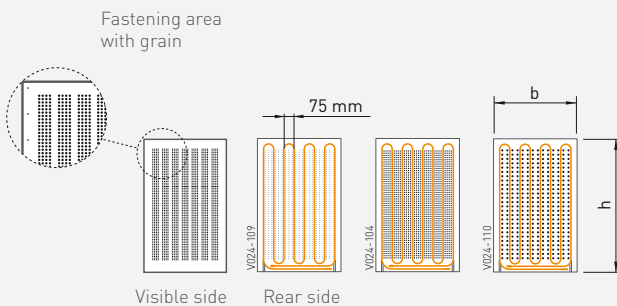

ModuleExpansionPanels

Part No.	Product code	Dimensions (h×b), [mm]	Height h, [mm]	Panel surface [m ²]	Effective surface [m ²]	Laid pipe in panel	Weight/ panel	Required quantity dry wall screws/panel			
								Longitudinal joists	Transverse joists		
ModulePanels-Classic											
V020-100	MDC-2000-625	2000×625	-	1.25	1.25	16.2 m	25.5 kg	18 pcs.	33 pcs.	25 pcs.	30 pcs.
V020-102	MDC-1000-625	1000×625	-	0.63	0.63	8.2 m	12.8 kg	10 pcs.	18 pcs.	9 pcs.	20 pcs.
V020-104	MDC-2000-312	2000×312	-	0.62	0.62	8.2 m	12.6 kg	18 pcs.	22 pcs.	10 pcs.	18 pcs.
V020-105	MDC-1500-625	1500×625	-	0.94	0.94	12.2 m	19.2 kg	14 pcs.	27 pcs.	15 pcs.	25 pcs.
V020-107	MDC-2500-625	2500×625	-	1.56	1.56	20.2 m	33.8 kg	22 pcs.	42 pcs.	21 pcs.	35 pcs.
V020-120	MDC-1000-625-V300	1000×625	300	0.63	0.48	6.7 m	13.0 kg	10 pcs.	18 pcs.	9 pcs.	20 pcs.
V020-122	MDC-2000-625-V200	2000×625	200	1.25	1.17	15.4 m	25.7 kg	18 pcs.	33 pcs.	25 pcs.	30 pcs.
V020-124	MDC-2000-625-V400	2000×625	400	1.25	1.04	14.2 m	25.8 kg	18 pcs.	33 pcs.	25 pcs.	30 pcs.
V020-126	MDC-2000-625-V600	2000×625	600	1.25	0.92	13.0 m	26.0 kg	18 pcs.	33 pcs.	25 pcs.	30 pcs.
V020-128	MDC-2000-625-V800	2000×625	800	1.25	0.79	11.8 m	26.2 kg	18 pcs.	33 pcs.	25 pcs.	30 pcs.
V020-101	MDC-2000-600	2000×600	-	1.20	1.20	16.2 m	24.5 kg	18 pcs.	33 pcs.	25 pcs.	30 pcs.
V020-103	MDC-1000-600	1000×600	-	0.60	0.60	8.2 m	12.2 kg	10 pcs.	18 pcs.	9 pcs.	20 pcs.
V020-106	MDC-1500-600	1500×600	-	0.90	0.90	12.2 m	18.4 kg	14 pcs.	27 pcs.	15 pcs.	25 pcs.
V020-108	MDC-2500-600	2500×600	-	1.50	1.50	20.2 m	30.6 kg	22 pcs.	42 pcs.	21 pcs.	35 pcs.
V020-121	MDC-1000-600-V300	1000×600	300	0.60	0.46	6.7 m	12.5 kg	10 pcs.	18 pcs.	9 pcs.	20 pcs.
V020-123	MDC-2000-600-V200	2000×600	200	1.20	1.12	15.4 m	24.6 kg	18 pcs.	33 pcs.	25 pcs.	30 pcs.
V020-125	MDC-2000-600-V400	2000×600	400	1.20	1.00	14.2 m	24.8 kg	18 pcs.	33 pcs.	25 pcs.	30 pcs.
V020-127	MDC-2000-600-V600	2000×600	600	1.20	0.88	13.0 m	24.9 kg	18 pcs.	33 pcs.	25 pcs.	30 pcs.
V020-129	MDC-2000-600-V800	2000×600	800	1.20	0.76	11.8 m	25.1 kg	18 pcs.	33 pcs.	25 pcs.	30 pcs.
ModuleExpansionPanels-Classic											
V021-100	MAC-2000-625	2000×625	-	1.25	-	-	27.1 kg	18 pcs.	33 pcs.	25 pcs.	30 pcs.
V021-102	MAC-1000-625	1000×625	-	0.63	-	-	13.6 kg	10 pcs.	18 pcs.	9 pcs.	20 pcs.
V021-128	MAC-1500-625	1500×625	-	0.94	-	-	20.4 kg	14 pcs.	27 pcs.	15 pcs.	25 pcs.
V021-126	MAC-2500-625	2500×625	-	1.56	-	-	33.9 kg	22 pcs.	42 pcs.	21 pcs.	35 pcs.
V021-101	MAC-2000-600	2000×600	-	1.20	-	-	26.0 kg	18 pcs.	33 pcs.	25 pcs.	30 pcs.
V021-103	MAC-1000-600	1000×600	-	0.60	-	-	13.0 kg	10 pcs.	18 pcs.	9 pcs.	20 pcs.
V021-129	MAC-1500-600	1500×600	-	0.90	-	-	19.5 kg	14 pcs.	27 pcs.	15 pcs.	25 pcs.
V021-127	MAC-2500-600	2500×600	-	1.50	-	-	32.6 kg	22 pcs.	42 pcs.	21 pcs.	35 pcs.

🔥 In the case of fire protection requirements, except where
test verification/certification is otherwise specified

Part No.	Product code	Dimensions (h×b), [mm]	D [mm]	R1 R2 [mm]	Panel surface [m ²]	Effective surface [m ²]	Laid pipe in panel	Weight/ panel	Required quantity dry wall screws/panel	
									Longitudinal joists	Transverse joists
ModulePanels-Acoustic										
V024-109	MSDA-1000-625-F06	1000×625	6	25.0 16.0	0.63	0.63	8.5 m	8.4 kg	10 pcs.	9 pcs.
V024-104	MSDA-1000-625-B08	1000×625	8	15.0 16.0	0.63	0.63	8.5 m	10.5 kg	10 pcs.	9 pcs.
V024-110	MSDA-1000-625-F12	1000×625	12	37.5 32.0	0.63	0.63	8.5 m	12.4 kg	10 pcs.	9 pcs.
ModuleExpansionPanels-Acoustic										
V021-113	MAA-1000-625-F06	1000×625	6	25.0 16.0	0.63	-	-	12.7 kg	10 pcs.	9 pcs.
V021-108	MAA-1000-625-B08	1000×625	8	15.0 16.0	0.63	-	-	11.6 kg	10 pcs.	9 pcs.
V021-114	MAA-1000-625-F12	1000×625	12	37.5 32.0	0.63	-	-	12.5 kg	10 pcs.	9 pcs.
V021-102	MAC-1000-625	1000×625	-	-	0.63	-	-	13.6 kg	10 pcs.	9 pcs.

2.3 Variomodular pipe 11.6x1.5 Laser

Advantages

- Fully corrosion-free
- Optimum creep behaviour
- Just as light as a plastic pipe
- 10-year guarantee with certificate
- Flexible, easy to bend, extremely stable form
- Resistant to hot water additives (inhibitors, antifreeze)
- Mirror-smooth inner surface – less pressure loss – no encrustation
- High pressure and temperature resistance (10 bar, +95 °C)
- 100 % oxygen diffusion-tight
- Low linear coefficient of expansion, low heat expansion forces
- Tested as per EN 21 003 (IMA Dresden), SKZ A 397

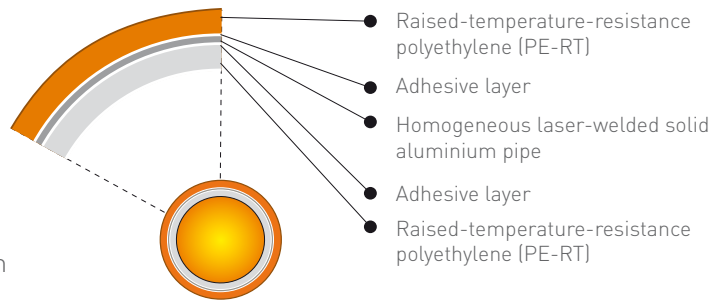

Elongation

with 10 m and temperature difference Δt 25 °C (e. g. 20 °C to 45 °C):

	Tubing	Elongation
Plastics	PEX (PKU)	50,00 mm
	PP	42,50 mm
	PB	32,50 mm
	PVC	20,00 mm
	Variomodular pipe	5,75 mm
Metal	Cu	4,20 mm
	Stainless steel	3,50 mm
	Steel	2,88 mm

Homogeneous plastic pipes produce high stress levels in the device because of their expansion coefficient.

The Variomodular pipe combines the minor elongation and thermal expansion. So it is perfect for surface heating- and -cooling pipes.

Technical data

Pipe diameter:	11.6 mm
Pipe wall thickness:	1.5 mm
Aluminium pipe thickness:	0.15 mm
Water content:	0.058 l/m
Special narrow bending radius (use a suitable bending device):	30 mm
Max. operating temperature:	$t_{max} = 95 \text{ °C}$
Short-term resistant:	$t_{mat} = 110 \text{ °C}$
Max. operating pressure:	$p_{max} = 10 \text{ bar}$
Linear expansion coefficient:	$2.3 \times 10^{-5} \text{ [K}^{-1}\text{]}$
Mean heat conduction coefficient:	$\lambda = 0.43 \text{ W/mK}$
Heat transmission resistance:	$R_{\lambda} = 0.0033 \text{ m}^2\text{K/W}$

Creep behaviour

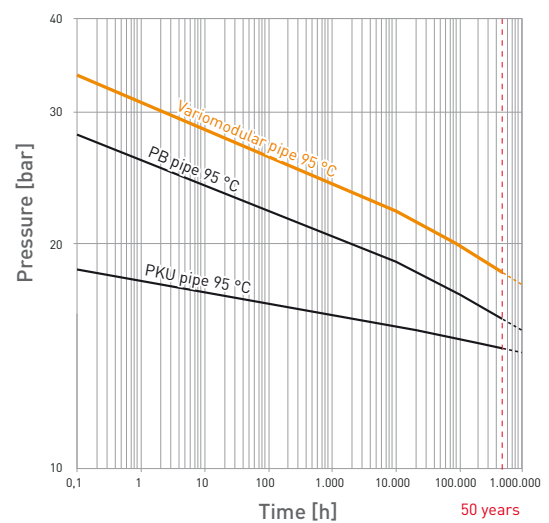

3 FIRE PROTECTION

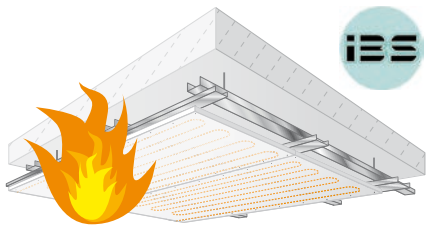

From a fire protection perspective, the 18 mm Variotherm ModulePanels correspond to a 12.5 mm FERMACELL gypsum fibreboard panel [Test IBS-Linz No. VFA2001-0389.01, fire protection assessment file number 10111710]. Please observe the corresponding FERMACELL regulations and FERMACELL fire protection assessments. (Does not apply to ModulePanels-Acoustic).

IBS - INSTITUT FÜR BRANDSCHUTZTECHNIK UND SICHERHEITSFORSCHUNG
 G E S E L L S C H A F T M. B. H.

STATUTLICH ANERKENNTES PRÜF- UND ÜBERWACHUNGSSTELLEN FÜR GEMÄSS AKKREDITIERUNGSBESCHLÜSSEN 92/140/EEG 68/180/EEG UND 89/140/EEG 65/609/EEG
 ZENTRALE A-4011 LINZ, RIFTALSTRASSE 45, POSTFACH 27, TEL. FÜR BÜRO 033761 810, FAX 033761 330
 ZWISCHENSTELLE A-1360 WELFENBRUNNEN, GIBBS-PAUL-STR. 109, 687, TEL. FÜR BÜRO 033761 810, FAX 033761 330, E-MAIL: INFO@IBS.LINZ
 AUSTRIA VÖLLKRAUT, GAFFENSTRASSE 8, TEL. FÜR BÜRO 033761 810, FAX 033761 330, E-MAIL: INFO@IBS.LINZ
 A-9100 DONAUBÜHLEN, STERNENSTR. 18, TEL. FÜR BÜRO 033761 810, FAX 033761 330, E-MAIL: INFO@IBS.LINZ
 www.ibs-linz.at 033761 810 033761 330 033761 810 033761 330 033761 810 033761 330

Variotherm Heizsysteme GmbH
 Herrn Ing. Thomas Baumgartner
 Günselödler Strasse 3a
 A- 2544 Leobersdorf

Datum: 17. November 2010
 Aktennummer: 10111710
 Bearbeiter: Dipl. Ing. (FH) U. Stöckl / hose
 DW: 872

Brandschutztechnische Beurteilung, Aktennummer: 10111710
Brandversuche entsprechend EN 1364, Teil 1 sowie EN 1365, Teil 2 sowohl eines unbelasteten Wandelementes als auch eines tragenden Deckenelementes der Firma Variotherm Heizsysteme GmbH

Aufgrund der in der Prüfstelle IBS Linz durchgeführten Brandprüfungen wird bestätigt, dass sowohl ein unbelastetes Wandelement als auch ein tragendes Deckenelement der Firma Variotherm Heizsysteme GmbH die Prüfanforderungen entsprechend EN 1364, Teil 1 sowie EN 1365, Teil 2 erfüllen.

Die Variotherm Modulplatten bestehend aus einer 18 mm Fermacell-Platte mit eingelegetem Mehrschichtverbundrohr 11,6 x 1,5/Alu 0,20 mm wurden zwei Brandprüfungen unterzogen:

- 1) Brandversuch einer **nichttragenden Wand** nach EN 1363-1 und EN 1364-1
 Prüfbericht Nr.: 10050617
 Prüfdatum: 31.08.2010
 Prüfdauer: 45 Minuten und 20 Sekunden
 Nach EN 13501-2 Kapitel 7.5.2 in die Feuerwiderstandsklasse EI 45 einzustufen
 Der Brandversuch vom 31.08.2010 am IBS Linz wurde dem Versuch mit der Prüfbericht Nr.: PG10934 vom 12.04.2002 am Danish Institute of Fire and Security Technology nachgestellt, bei dem eine Versuchszeit von 35 Minuten erreicht wurde.
- 2) Brandversuch eines **tragenden Deckenelementes** nach EN 1363-1 und EN 1365-2
 Prüfbericht Nr.: 10050618
 Prüfdatum: 28.09.2010

IBS - Institut für Brandschutztechnik und Sicherheitsforschung Gesellschaft m.B.H.
 A-4017 Linz, Poststraße 45, Postfach 27
 Akkreditierte Prüf- und Inspektionsstelle

Beurteilung Nr.: 10111710
 Datum: 17.11.2010
 Seite 2 von 2
 Auftraggeber: VARIOTHERM

Prüfdauer: 100 Minuten und 20 Sekunden
 Nach EN 13501-2 Kapitel 7.3.3 in die Feuerwiderstandsklasse REI 90 einzustufen
 Der Brandversuch vom 28.09.2010 am IBS Linz wurde dem Versuch mit der Prüfbericht Nr.: MA39-VFA 2002-2173.01 vom 14.04.2003 bei der Magistratsabteilung 39 der Versuchs- und Forschungsanstalt der Stadt Wien nachgestellt, bei dem eine Versuchszeit von 94 Minuten erreicht wurde.

Brandschutztechnische Beurteilung

Die Brandversuche, die am IBS durchgeführt wurden waren im Aufbau ident mit jenen Brandversuchen, die in den oben angeführten Prüfprotokollen durchgeführt wurden, jedoch mit dem Unterschied, dass die feuerzugewandten 12,5 mm dicken Fermacell-Platten durch 18 mm dicke Variotherm Modulplatten ersetzt wurden.

Aufgrund der vorliegenden Versuchsergebnisse nach ÖNORM EN 1364, Teil 1 sowie ÖNORM EN 1365, Teil 2 kann festgestellt werden, dass mit den 18 mm dicken Variotherm Modulplatten mindestens gleiche Ergebnisse erreicht wurden, wie mit den 12,5 mm dicken Fermacell-Platten, weshalb eine direkte Vergleichbarkeit vorliegt.

Somit kann bestätigt werden, dass in Leichtbaukonstruktionen (Wände, Decken, Dachschrägen), die üblichen 12,5 mm dicken Fermacell-Platten durch 18 mm dicke Variotherm Modulplatten ersetzt werden dürfen, ohne dadurch Nachteile hinsichtlich des Feuerwiderstandes zu erhalten.

IBS - INSTITUT FÜR BRANDSCHUTZTECHNIK UND SICHERHEITSFORSCHUNG GESELLSCHAFT M.B.H.
 Akkreditierte Prüf- und Inspektionsstelle

Dipl.-Ing. (FH) Ulrich STÖCKL
 Sachbearbeiter

Ing. Josef KRAML
 Bereichsleiter der Prüfstelle

Dir.-Stv. Ing. Helmut PEHERSTORFER
 Zeichnungsberechtigter
 Geschäftsführer

© IBS - Institut für Brandschutztechnik und Sicherheitsforschung Gesellschaft m.B.H. 2010

Examples of fire protection fittings

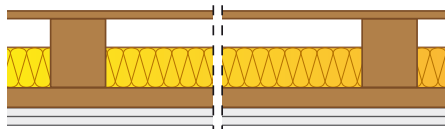

ceiling structure with 12.5 mm Fermacell gypsum fibreboards

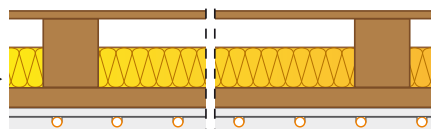

with Variotherm ModulePanel

Fire resistance as per ÖN EN 13501-2: REI 60*

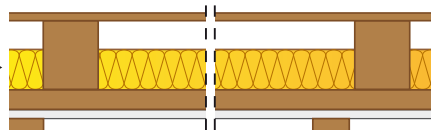
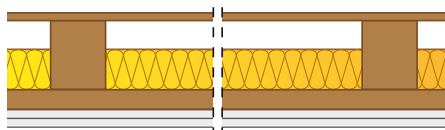

Fire resistance as per ÖN EN 13501-2: REI 60*
 (Variant with intermediate battens; also confirmed by IBS Linz)

* For details regarding wall fittings, please refer to the Fermacell planning documents.

4 SUBSTRUCTURE

please observe the planning and installation guidelines of the manufacturer of the wooden or drywall system used for your ceiling construction.

- With wooden constructions, the timber used must be sufficiently dry and straight, and conform to the Austrian standard DIN 4074-1 (quality class 2 and cutting class S = sharp-edged).
- With metal constructions, the profiles must be made of soft, non-alloyed steel with double-sided galvanising of at least 100 g/m² according to the Austrian standard DIN 18182-1 or DIN EN 14195.
- The construction has to be designed to carry the weight of the ModulePanels (20.5 kg/m²) and any eventual additional loads (e.g. ceiling lights). Additional loads such as ceiling lights, multi-layer planking and other fittings must also be taken into account! See also chapter 9.3.
- Do not glue the ModulePanels directly to the ceiling (plaster).

4.1 Dimensions in border area

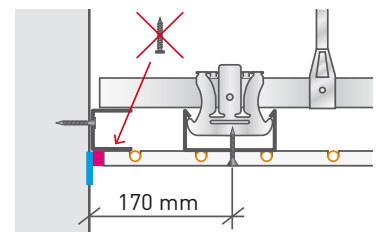
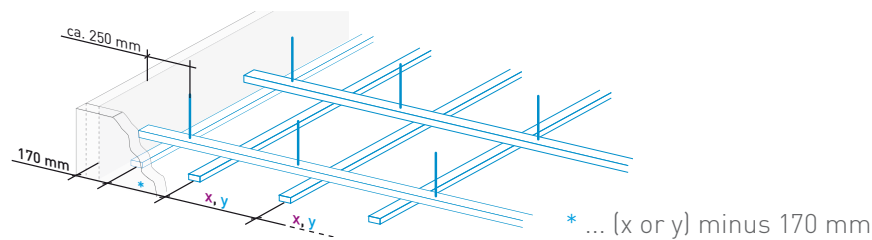

4.2 Main joists/main profiles

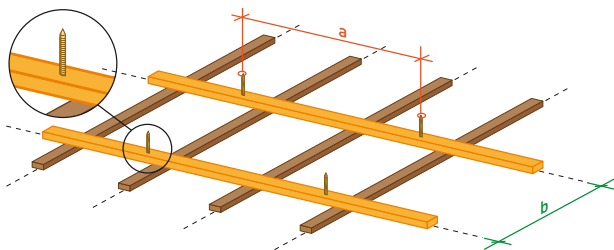

WOODEN SUBSTRUCTURE:
DIRECTLY FASTENED
MAIN JOISTS

	Joist dimensions w × h [mm]	Max. permissible span for loads of up to 30 kg/m ² ± ModulePanel (20.5 kg/m ²) + light additional load (up to 9.5 kg/m ²)	Max. permissible span for loads of up to 50 kg/m ² ± ModulePanel (20.5 kg/m ²) + heavy additional load (up to 29.5 kg/m ²)
Max. clearance direct attachment (a)	Main joists 48 × 24	650 mm	600 mm
	Main joists 50 × 30	750 mm	600 mm
	Main joists 60 × 40	850 mm	700 mm
Max. axis clearance main joists (b)	Cross joists 48 × 24	600 mm	500 mm
	Cross joists 50 × 30	750 mm	600 mm
	Cross joists 60 × 40	1000 mm	900 mm

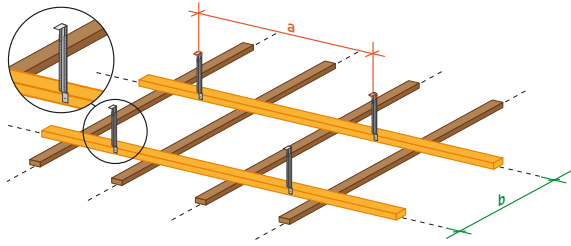

WOODEN SUBSTRUCTURE: SUSPENDED MAIN JOISTS

	Joist dimensions w × h [mm]	Max. permissible span for loads of up to 30 kg/m ² ≙ ModulePanel (20.5 kg/m ²) + light additional load (up to 9.5 kg/m ²)	Max. permissible span for loads of up to 50 kg/m ² ≙ ModulePanel (20.5 kg/m ²) + heavy additional load (up to 29.5 kg/m ²)
Max. clearance suspension element (a)	Main joists 30 × 50*	850 mm	700 mm
	Main joists 40 × 60	1000 mm	850 mm
Max. axis clearance main joists (b)	Cross joists 48 × 24	600 mm	500 mm
	Cross joists 50 × 30	750 mm	600 mm
	Cross joists 60 × 40	1000 mm	900 mm

* Only in conjunction with cross joists that are 50 mm wide and 30 mm high

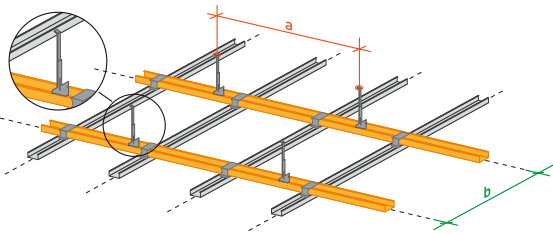

METAL SUBSTRUCTURE: SUSPENDED MAIN PROFILE

	Profile dimensions** [mm]	Max. permissible span for loads of up to 30 kg/m ² ≙ ModulePanel (20.5 kg/m ²) + light additional load (up to 9.5 kg/m ²)	Max. permissible span for loads of up to 50 kg/m ² ≙ ModulePanel (20.5 kg/m ²) + heavy additional load (up to 29.5 kg/m ²)
Max. clearance suspension element (a)	Main profile CD 60 × 27 × 06	750 mm	600 mm
Max. axis clearance base profile (b)	Cross profile CD 60 × 27 × 06	1000 mm	750 mm

** Standard steel sheet profiles (as per ÖNORM/DIN 18 182 or ÖNORM/DIN EN 14 195)

4.3 Cross joists/cross profiles

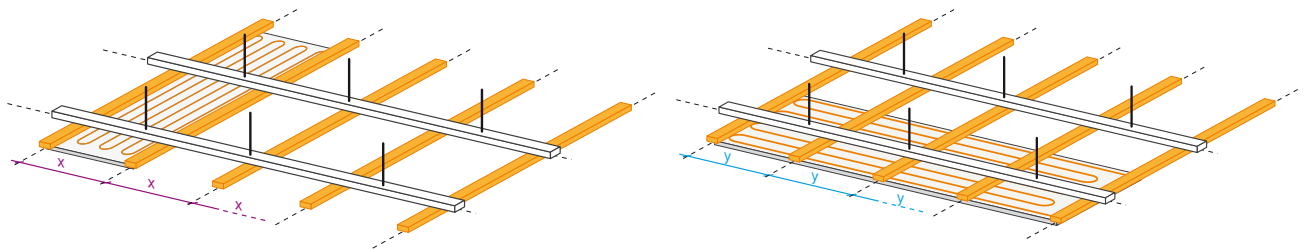

Panel size w × b [mm]	ModulePanels-Classic									
	2500 × 625	2500 × 600	2000 × 625	2000 × 600	1500 × 625	1500 × 600	1000 × 625	1000 × 600	2000 × 312	-Acoustic 1000 × 625
Max. axis clearance [mm] longitudinal cross joists (x)	625.0 312.5🔥	600.0 300.0🔥	625.0 312.5🔥	600.0 300.0🔥	625.0 312.5🔥	600.0 300.0🔥	625.0 312.5🔥	600.0 300.0🔥	312.0 312.0🔥	625.0
Max. axis clearance [mm] transverse cross joists (y)	416.7 416.7🔥	416.7 416.7🔥	500.0 400.0🔥	500.0 400.0🔥	375.0 375.0🔥	375.0 375.0🔥	500.0 333.3🔥	500.0 333.3🔥	500.0 400.0🔥	500.0

🔥 In the case of fire protection requirements, except where test verification/certification is otherwise specified

4.4 Directly fastened cross joists (variant without main joists)

For axis clearances of the supporting battens, see Sections 4.1 to 4.3. Due to the low construction height it is necessary to interrupt the substructure approx. 200 mm after the end of the panel. This is followed by an intermediate space of 200 mm for supply lines and/or press connections of the ModulePanels.

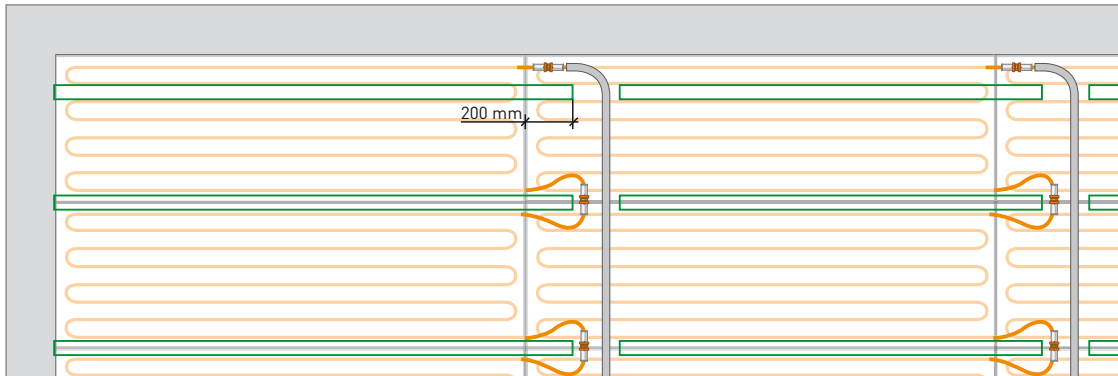

4.5 Movement joints

Movement joints are to be provided every 8 m in ceiling constructions.

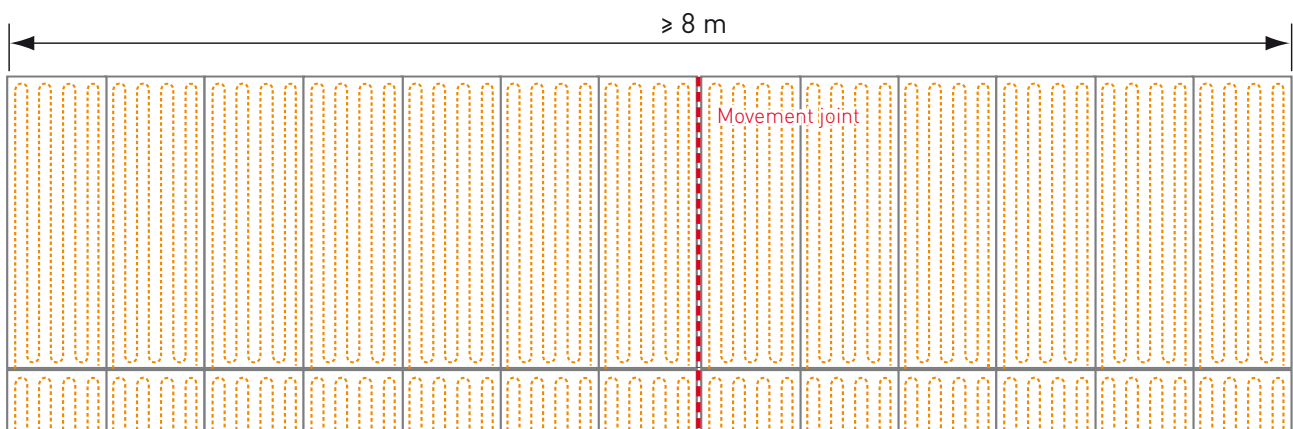

▲ Movement joint at (e. g.) 13×V020-100 (13×0.625 m = 8.13 m)

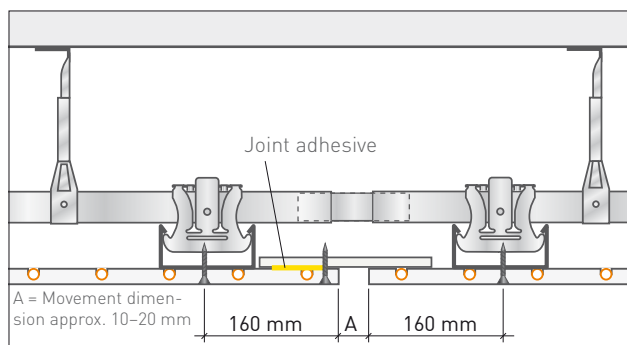

▲ Movement joint with panel strip

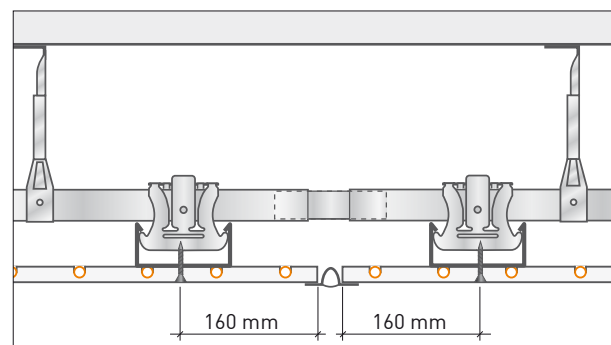

▲ Movement joint with additional profile

4.6 Residual areas and panel transitions

The areas at the sides of the ModulePanels are filled out using ModuleExpansionPanels (please observe the FERMACELL guidelines). These panels without pipes are also glued with joint adhesive on the front side. The width of the ModuleExpansionPanels should not be less than 200 mm.

Cross joints are to be avoided. Inner and outer corners and T-joints are to be constructed as grouted joints (approx. 7 mm) ■ with a separating layer ■ (decoupled connection).

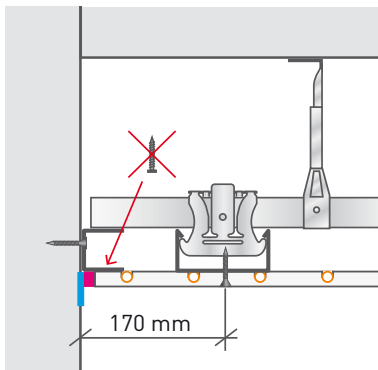

▲ Connection with UD profile –
Cross joints longitudinal to the panel

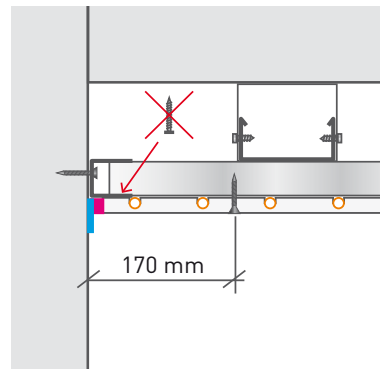

▲ Connection with UD profile –
Cross joints transverse to the panel

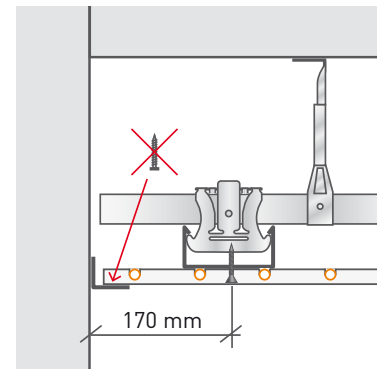

▲ Connection with angled beading

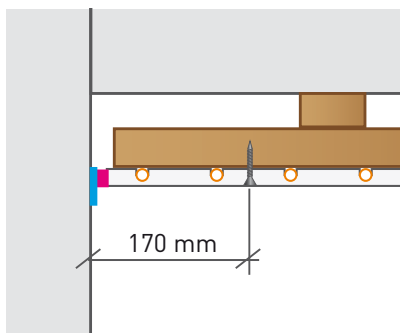

▲ Connection with separating layer

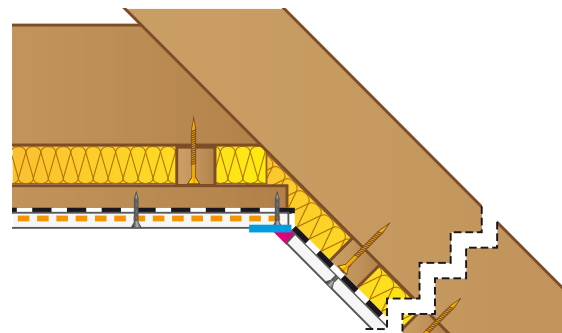

▲ ModuleCeiling to roof pitch

ModulePanel to plasterboard panels:

Variotherm provides no guarantee for transitions to products from other panel manufacturers. Please observe the specifications of the respective (panel) manufacturer.

We can however provide you with four practical examples of transition methods:

- Grouted joints (approx. 7 mm) ■ with a separating layer ■ (decoupled connection). Advantage: intentional straight crack (usually hardly visible)
- Elastic seam (acrylic mass), (maintenance seam, not suitable for fire prevention constructions)
- Fascia
- Wooden strip fastened on one side for covering the transition

5 COOLING/THERMAL PERFORMANCE

5.1 Calculation of the cooling and heating load

Variotherm also conducts cooling load calculations (subject to a fee) according to the new VDI 2078 guideline (valid since June 2013). For calculation purposes, precise information must be provided on the building and the rooms to be cooled (U-values with layer composition, shading, internal loads). This is the precondition for useful, accurate results.

The EN 12831 standard with the respective national annex applies to the heating load calculations for the heated rooms. Every room is considered individually. For the outside temperature, the locally acquired and standardised outdoor temperature T_{ne} is used.

Bezeichnung	Fläche m²	Kühllast W	Kühllast W/m²	t _{Raum} °C	t _{op, Raum} °C
Schlafzimmer	21.70	-1601	-73.76	24.0	23.9
Wohnen, Kochen, Essen	84.50	-2906	-34.39	24.0	24.8
Wirtschaftsraum	13.00	-455	-35.01	24.0	24.6
WC	4.60	-73	-15.89	24.0	24.1
Corridor + Stiege	29.40	-1822	-61.96	24.0	25.4
Lounge + Stiege	22.00	-459	-20.85	24.0	24.3
Küche II (Pantry)	30.50	-956	-31.35	24.0	24.8
Vorraum	10.00	-239	-23.94	24.0	24.5
Küche II (Pantry)	14.00	-414	-29.55	24.0	24.6
Gästezimmer 1	23.50	-613	-26.08	24.0	24.6
Flur + Stiege	12.40	-342	-27.59	24.0	24.6
Gästezimmer 2	28.70	-746	-25.98	24.0	24.5
Summe	294.30	-10625	-36.10		

▲ Extract from a cooling load calculation

Code	Bezeichnung	U-Wert W/m²K	Rges m²K/W	Rsi m²K/W	Rse m²K/W	R-Baut m²K/W
AF01	Außenfenster	1.100	0.909	0.130	0.040	0.739
AT01	Außentür	1.700	0.588	0.130	0.040	0.418
AW01	Außenwand	0.220	4.545	0.130	0.040	4.375

Raum	Φ _{ext}	A _f	Φ _{ra}	Φ _p	Φ _v	Φ _{neuW}	Φ _{neuH}	Φ _{neuL}	Φ _{BR}	Φ _{SL}
Haus, EG	180.88	5427	3396						9160	0
00.001.001 Eltern	20.0	29.10	833	833	501	46	15	1335	0	1335
00.001.002 Kinder	20.0	20.49	762	762	343	54	19	1106	0	1106
00.001.003 Vorräum	20.0	24.40	571	571	408	40	14	980	0	980
00.001.004 Bst	24.0	17.98	508	508	460	64	23	923	0	923

▲ Extract from a heating load calculation

5.2 Variotherm dimensioning softwares

Key values for individual cooling/heating circuits (the amount of water, pressure loss, number of circuits, allocation of the manifolds etc.) can be quickly and easily calculated by inputting the cooling or heating load into the Variotherm dimensioning softwares. It can be found in our Professional Area at www.variotherm.com/profi.

Bauvorhaben: _____ PLZ: _____ Ort: _____ Datum: _____ Bearbeiter: as

Nr	Raum Bezeichnung	Raumgründe		Kühlast Auf [%]	Kühlast ins. Aufs. schlag [W]	Raum-Temp. t [°C]	Kühlsystem	Aus-lags-temperatur t _l [°C]	rechnerisch			praktisch			Zuleitung Rohr	Zuleitungs-Länge pro Kühlkreis [m]	Druckverlust pro Kühlkreis [mWS]	Durchflussmenge pro Kühlkreis [kg/h]	Kühlkreis-verteiler	Sonderfall 2 Kühlsysteme an einem Kühlkreis (siehe Anleitung)
		A [m²]	O [m]						Aus-lagsung	Einhl.	Typ	Anz. Kreise	Einhl. Aus-lagsung	Rest-leistung						
	Zimmer	21.16	1.021	0	1.021	26	ModulDecke MSD/MRD	16/20	17.02 m²	MSD/MRD	3	5.8 m³	23	2.61	75	●1				
	Garderobe	10.15	564	0	564	26	ModulDecke MSD/MRD	16/20	9.40 m²	MSD/MRD	2	4.5 m³	-24	1.50	59	●1				
	Zimmer	23.04	1.032	0	1.032	26	ModulDecke MSD/MRD	16/20	17.20 m²	MSD/MRD	3	5.8 m³	12	2.61	75	●1				
	Gang	0	335	0	335	26	ModulDecke MSD/MRD	16/20	5.99 m²	MSD/MRD	1	6 m³	25	2.90	78	●1				
	Wohnküche	33.14	1.543	0	1.543	26	ModulDecke MSD/MRD	16/20	25.72 m²	MSD/MRD	5	5.4 m³	77	2.15	70	●1				
	Wohnküche und Gang	46.00	1.754	0	1.754	26	ModulDecke MSD/MRD	16/20	29.24 m²	MSD/MRD	5	6.2 m³	106	3.20	81	●2				
	Zimmer	26.04	1.245	0	1.245	26	ModulDecke MSD/MRD	16/20	20.75 m²	MSD/MRD	4	5 m³	-15	1.75	65	●2				
	Zimmer	17.08	954	0	954	26	ModulDecke MSD/MRD	16/20	15.90 m²	MSD/MRD	3	5 m³	-54	1.75	65	●2				
		0	0	0	0															
		0	0	0	0															
		0	0	0	0															
		0	0	0	0															
		0	0	0	0															
		0	0	0	0															
		0	0	0	0															

Zusammenfassung der Kühlsysteme	
Menge	Einhl. Kühlsystem Rohr
142.8 m²	Modul-Deckenkühlung MSD/MRD 1.999,2 lfm
m²	System-Wandkühlung SWHK2
m²	System-Wandkühlung SWHK3
m²	Modul-Wandkühlung MSW
m²	Easy/Flex-Wandkühlung EWHK77
m²	Easy/Flex-Wandkühlung EWHK115
m	Zuleitung 10x2
m	Zuleitung 11,6x1,5
	Summe Füllwasser 116,0 Liter

Zusammenfassung Rohrlängen nach Zellen			
Zelle	Raum	m 8, 16	m 8, 11,6
1	Zimmer	243,6	14
2		16	15
3	Garderobe	126,0	16
4		17	18
5	Zimmer	243,6	18
6		19	20
7	Gang	84,0	20
8		21	22
9	Wohnküche	378,0	23
10		23	24
11	Wohnküche und	434,0	24
12		25	25
13	Zimmer	280,0	25
	SUMME		1.999,2

	t _l	Anzahl der Kühlkreise	Durchflussmenge [kg/h]	Max. Druckverlust +0,1 mWS für Verteiler [mWS]	Verteilerzuordnung lt. Plan
Kühlkreisverteiler #1	16/20	14	996	3,30	A
Kühlkreisverteiler #2	16/20	12	860	3,30	B
Kühlkreisverteiler #3					
Kühlkreisverteiler #4					
Kühlkreisverteiler #5					
Bei Anpassung aller Kühlkreisverteiler über eine Pumpe gilt:					
Gesamtdurchflussmenge:			1856	kg/h	
Maximaler Druckverlust ab Kühlkreisverteiler inkl. 0,1 mWS für max. geöffnetes Ventil			3,30	mWS	

▲ Variotherm dimensioning software example for cooling

5.3 Cooling performance

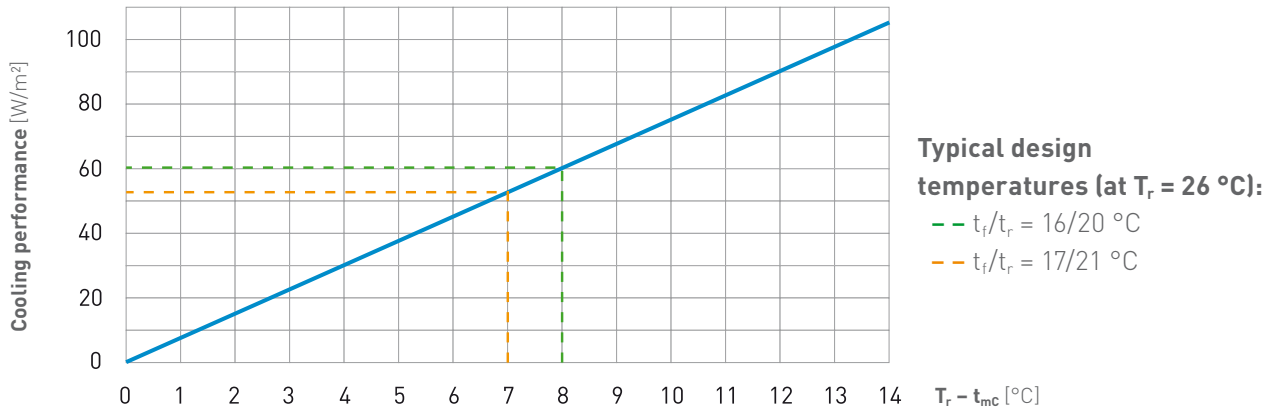

The surface temperature must not reach or fall below the dew point temperature!
 The mean surface temperature T_0 corresponds approximately to the return temperature t_r .

Relative humidity [%rH]	Room temperature [T_r]				
	24 °C	25 °C	26 °C	27 °C	28 °C
70 %	18.0	19.0	20.0	21.0	22.0
60 %	15.5	16.5	17.5	18.5	19.2
50 %	13.0	14.0	15.0	15.8	16.8
40 %	9.8	10.5	11.5	12.5	13.2

$$t_{mc} = \text{mean cooling water temperature} = \frac{t_f + t_r}{2} \text{ [°C]}$$

T_0 = mean surface temperature [°C]

T_r = room temperature [°C]

t_f/t_r = flow temperature / return temperature [°C]

5.4 Heat output tables

Chart valid with ceiling height 2.5–3.5 m.

Do not exceed $t_{mH} = 35\text{ °C}$ ($t_f/t_r = 40/30\text{ °C}$) because of reasons of comfort!

t_f/t_r [°C]	t_{mH} [°C]	Heat output [W/m²] at room temperature ...					T_0 [°C] (at $T_r = 20\text{ °C}$)
		... 15 °C	... 18 °C	... 20 °C	... 22 °C	... 24 °C	
30/20	25.0	55	39	27	15	-	27
30/25	27.5	68	54	41	28	15	28
35/25	30.0	82	67	55	42	28	29
35/28	31.5	90	75	62	49	36	30
35/30	32.5	96	81	68	55	42	31
37.5/32.5	35.0	110	95	82	69	55	32
40/30	35.0	110	95	82	69	55	32

$$t_{mH} = \text{mean hot water temperature} = \frac{t_f + t_r}{2} \text{ [°C]}$$

T_0 = mean surface temperature [°C]

T_r = room temperature [°C]

t_f/t_r = flow temperature / return temperature [°C]

6 PIPING

Example of ModuleCeiling (cooling case)

e.g. TOUCH HK

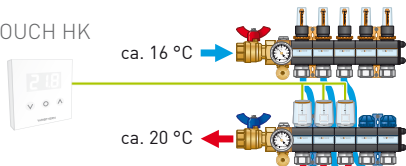

Distribution manifolds can also be mounted on the ceiling.

Supply pipes: pre-insulated Variomodular pipes 16x2 Laser

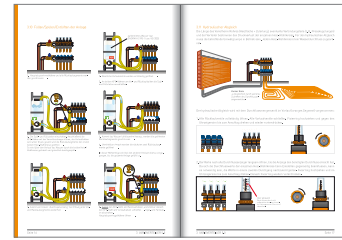

▲ Details regarding the system and heating circuit pipes and the room temperature control are provided in the DISTRIBUTION and CONTROL design and installation manual

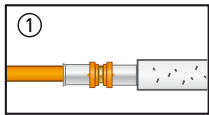

Press-fit coupling 16x11,6

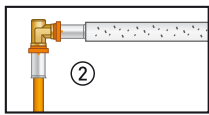

Press-fit brackets 90° 16x11,6

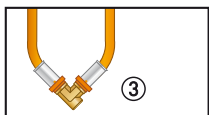

Press-fit brackets 90° 11,6x11,6

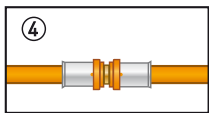

Press-fit coupling 11,6x11,6

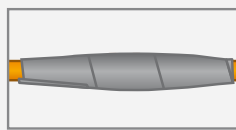
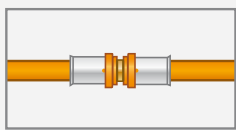
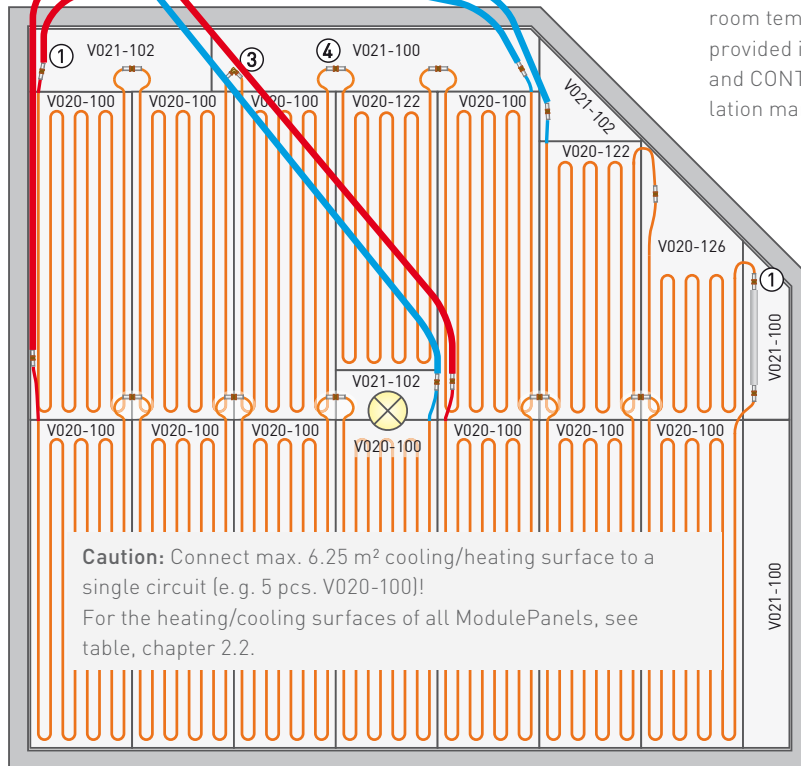

Corrosion protection measures:

According to ÖN H 5155, the joints should be protected after the pressure test (e.g. using cold shrink tape or corrosion protection tape).

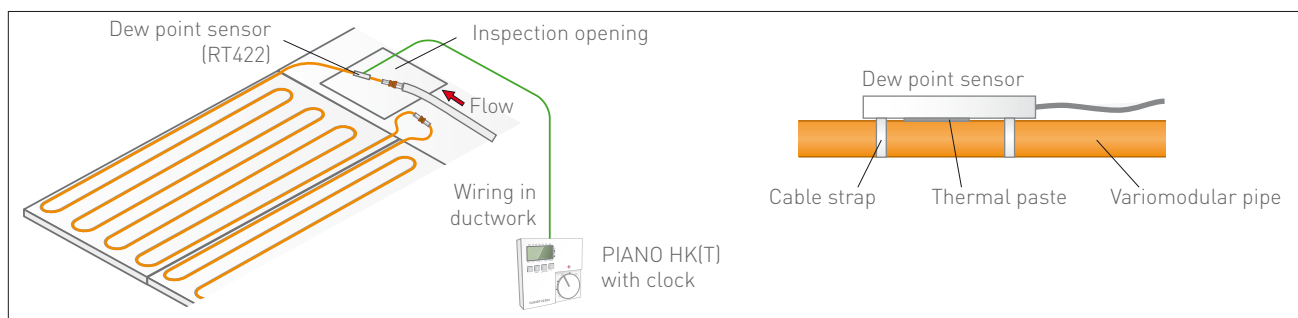

▲ Dew point sensor example

7 ARRANGEMENT OF THE SURFACES

Ceilings and pitched roofs are ideally suited for use as cooling and heating surfaces because the radiant surfaces are not impeded by room furnishings.

Experience has shown that the comfort effect is perceived at a distance of up to 3.5 m from the thermally active ceiling. In higher rooms it is therefore advantageous to suspend the ceiling because the radiance effect on the body declines in proportion to the square of the distance.

Estimated values for dimensions:

- 70–80 % ceiling surface of the room area for cooling
- 50–60 % ceiling surface of the room area for heating

Caution: Observe the heating/cooling load calculation for precise dimensioning of the area required!

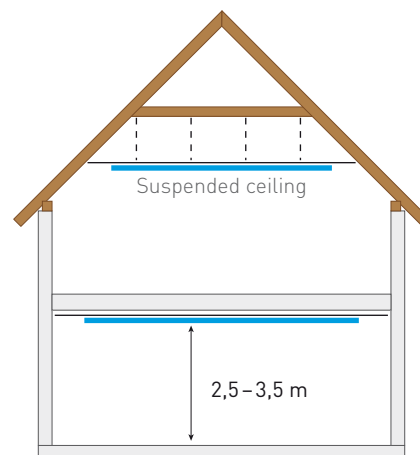

ModuleCeiling as “ceiling element”

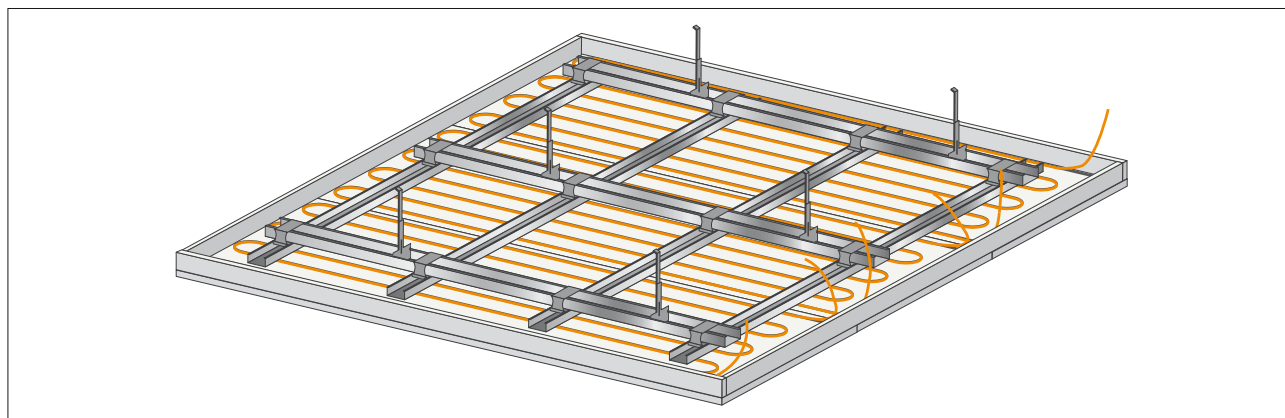

▲ Ceiling element example

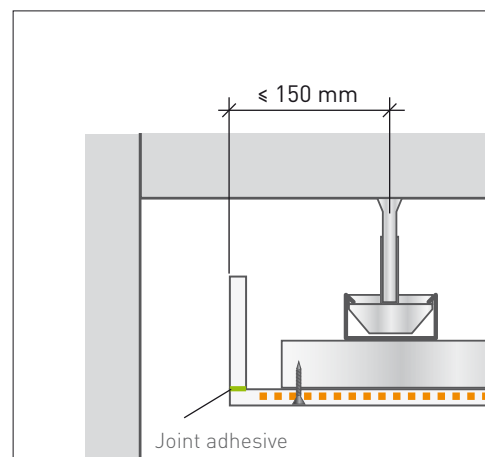

8 PRESSURE LOSS

Example: The total pressure loss Δp_{total} of a 6.25 m² ModulCeiling (5 pcs. V020-100 at one cooling circuit) is to be calculated. The desired flow/return temperature is 16/20 °C, resulting in a heat output of 60 W/m² at a room temperature of 26 °C.

The total pressure loss Δp_{total} is calculated using the following components:

- Pipes and press-fit couplings
- Heating/cooling distribution manifold
- Boiler house (mixing valve, boiler ...)

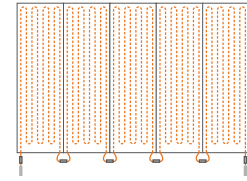

1.) Pipes and press-fit couplings

Calculation of the flow rate ω from the pressure loss diagram:
 $Q = 375 \text{ W}$ ($60 \text{ W/m}^2 \times 6.25 \text{ m}^2$)
 $\Delta T = 4 \text{ K}$ ($t_r/t_i = 16/20 \text{ °C}$)
 $\text{Flow volume } m = Q / c / \Delta T = 375 \text{ W} / 1.163 \text{ Wh/kgK} / 4 \text{ K} = 80.6 \text{ kg/h}$
 A flow volume $m = 80.6 \text{ kg/h}$ (= l/h) yields a flow rate $\omega = 0.4 \text{ m/s}$

Pipe length in ModulePanel (see table chapter 2.2)		
V020-100	MDC-2000-625	16.2 m
Press-fit coupling	Coefficient of resistance ζ [Zeta]	
16 x 11.6	6.9	
11.6 x 11.6	7.2	
Density of water ρ (Rho)		1000 kg/m ³
Specific heat capacity of water c		1.163 Wh/kgK

- Δp for 15 m pre-insulated Variomodular pipe 16x2: $60 \text{ Pa/m} \times 15 \text{ m} = 900 \text{ Pa}$
- Δp for 6.25 m² ModulPanels (5 pcs. V020-100): $342 \text{ Pa/m} \times [5 \text{ pcs.} \times 16.2 \text{ m} = 81 \text{ m}] = 27702 \text{ Pa}$
- Δp for 4 pcs. press-fit couplings 11.6x11.6: $\zeta \times \rho/2 \times \omega^2 = 7.2 \times 500 \text{ kg/m}^3 \times (0.4 \text{ m/s})^2 = 576 \text{ Pa} \times 4 \text{ pcs.} = 2304 \text{ Pa}$
- Δp for 2 pcs. press-fit couplings 16x11.6: $\zeta \times \rho/2 \times \omega^2 = 6.9 \times 500 \text{ kg/m}^3 \times (0.4 \text{ m/s})^2 = 552 \text{ Pa} \times 2 \text{ pcs.} = 1104 \text{ Pa}$

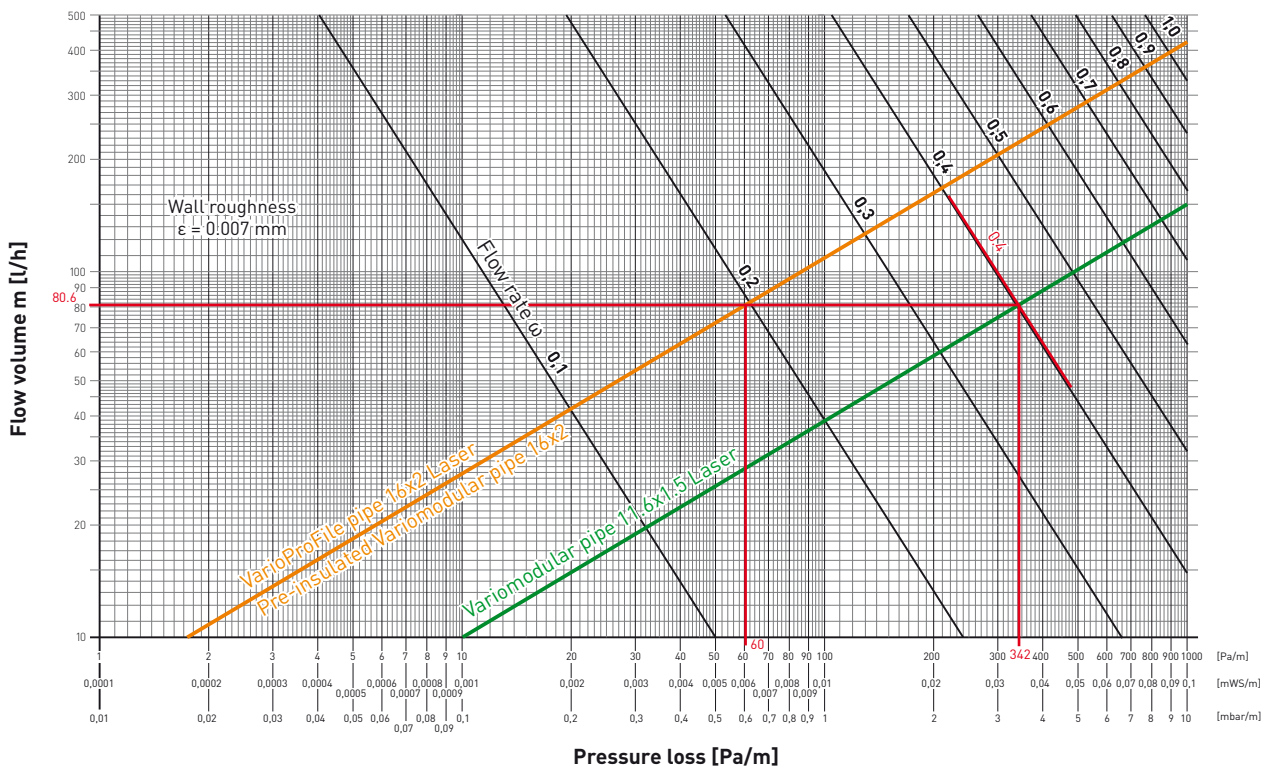

2. Heating/cooling distribution manifold

The flow rate characteristic curves for calculating the pressure loss of the heating/cooling distribution manifold for the heating circuits in question.

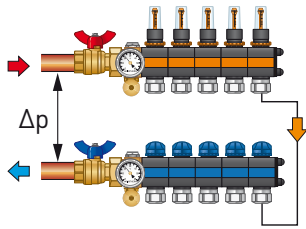

- Δp of the heating/cooling distribution manifold with an open valve up to $80.6 \text{ l/h} = 900 \text{ Pa}$

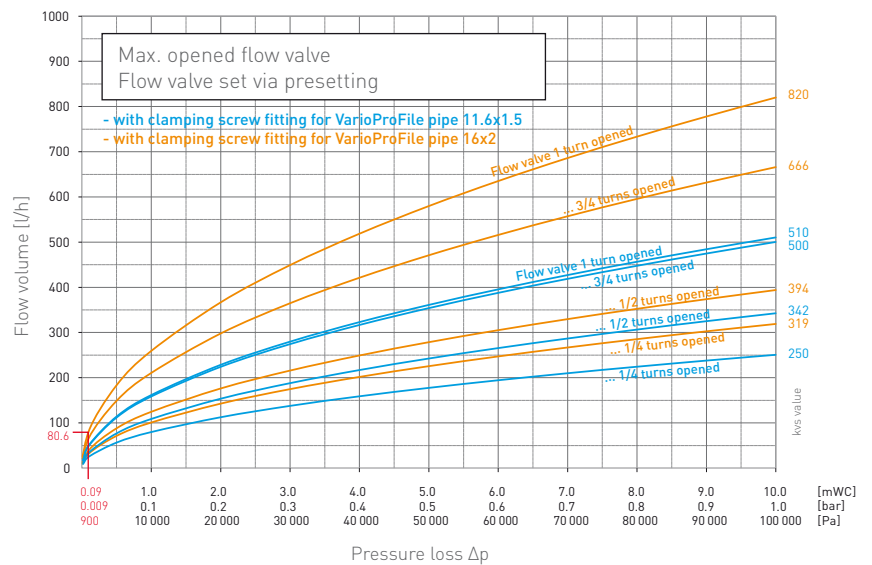

3. Boiler house (assumptions)

- Δp Mixing valve = 6000 Pa
- Δp Connection piping = 3500 Pa
- Δp Boiler = 3000 Pa

4. Total pressure

- $\Delta p_{\text{total}} = 45410 \text{ Pa} = 4.5 \text{ mWC}$

5.) Selection of the heating circulation pump (example: Wilo Yonos PICO Plus 25/1-6)

At the calculated pressure loss of 4.5 mWC the pump supplies a maximum volume flow of 1.3 m³/h.

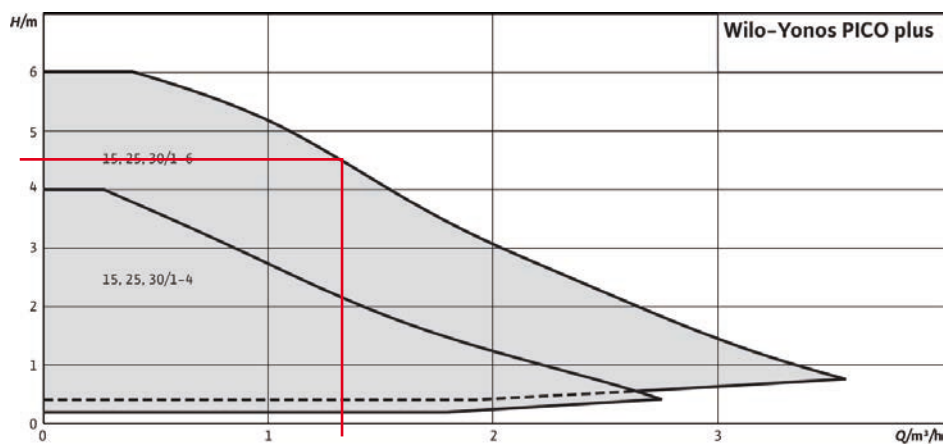

- ▲ Example: Wilo Yonos PICO Plus 25/1-6 heating circulation pump

9 FINISHED SURFACE

9.1 Stopping

Caution: Stopping must not be performed until all wet work has dried out (wet screed, plastering work, etc.)! After installation, the ModulePanels and the ModuleExpansionPanels are stopped using FERMACELL grouting or fine stopper.

The following work is to be performed, depending on the surface quality required:

Q1	• Stopping of visible joints and adhesive seams with FERMACELL grouting
Q2	• Q1 + burr-free and step-free stopping of the seams and joints
Q3	<p>Full-surface stopping:</p> <ul style="list-style-type: none"> • Stopping of the visible joints with FERMACELL grouting or plaster • Wide stopping of the seams • Full-surface coating and sharp pulling-off using FERMACELL grouting or fine stopper or other suitable stopping material
Q4	<p>Full-surface coating:</p> <ul style="list-style-type: none"> • Stopping of the visible joints with FERMACELL grouting or plaster • Wide stopping of the seams • Full-surface coating and smoothing using FERMACELL fine stopper or plaster or other suitable stopping material

9.2 Painting

Commonly available paints such as e.g. latex, emulsion or enamel paint can be applied to the ModulePanels. Mineral-based paints such as e.g. limewash and silicate paints must be approved by the manufacturer for use on gypsum fibre boards. The paint is usually applied in two steps.

9.3 Fastening loads to the ModuleCeiling

Low “static” loads can be fixed directly on the ModuleCeiling as prescribed by the following table (Do not damage the Variomodular pipes!):

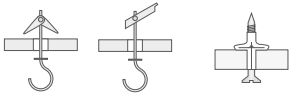
Fixing components - Observe the instructions of the dowel manufacturer!	Permissible single loads for individual hanging on ModulePanel (dowel distance \geq 300 mm)	Max. permissible area load per m ² ModulePanel (dowel distance \geq 300 mm)
	2 kg	6 kg

Heavier suspended elements must only be attached to the substructure and not to the ModulePanels. Additional loads must be designed for the substructure (see max. permissible span, chapter 4).

10 ACOUSTIC

10.1 General

Variotherm also offers ModulePanels with sound absorbent properties that significantly reduce the sound levels in living areas and offices. The holes in the gypsum fibre boards channel the impinging sound waves through the panel, where the sound energy is then “broken” and dispersed in the ceiling structure.

A special detail: With the Variotherm ceiling cooling/heating system, the holes of the acoustic panels are not covered by cooling/heating elements and thus remain 100 % active. This allows a tested and guaranteed sound reduction to be achieved.

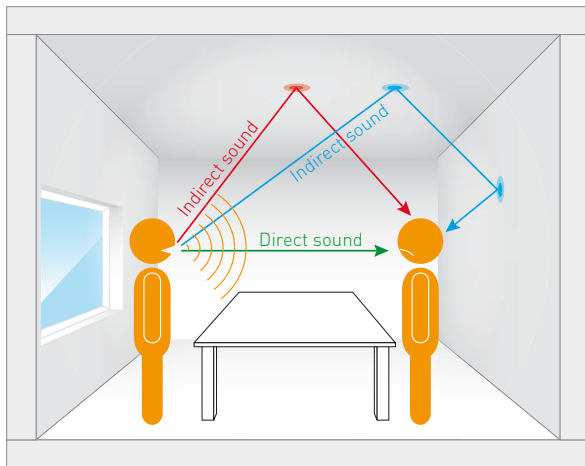

▲ Acoustic reflection

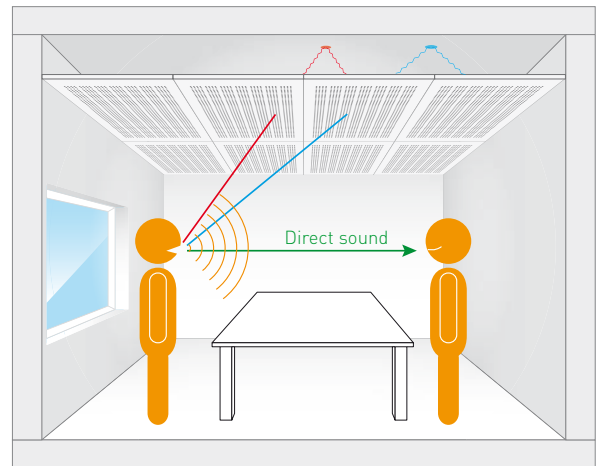

▲ Acoustic reflection with ModulePanel-Acoustic

10.2 Panel variants

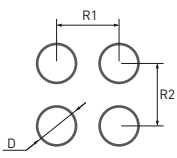
	F06	B08	F12
			
Hole diameter (D):	6 mm	8 mm	12 mm
Hole spacing (R1):	25.0 mm	15.0 mm	37.5 mm
Hole spacing (R2):	16.0 mm	16.0 mm	32.0 mm
Hole percentage:	4.8 %	12.4 %	6.6 %
Delivery time:	on stock	on stock	on stock
Hole pattern:	Continuous holes	Block holes	Continuous holes
Panel material:	Gypsum fibreboard which has been tested for their healthy building properties, 18 mm		
Panel size:	1000 × 625 mm		
Pipe:	Variomodular pipe 11.6x1.5 Laser		
Rear side:	Acoustic fleece AV 100, black		

10.3 Acoustic values

F06

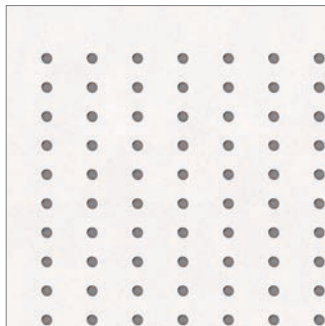

 Tested by TÜV Rheinland per DIN EN ISO 354

Data source: LGA/TÜV Rheinland Certificate
Test number: 60233327-001
Valid for: Ceiling
Fleece: AV 100
Insulation: Rockwool Sonorock or equivalent

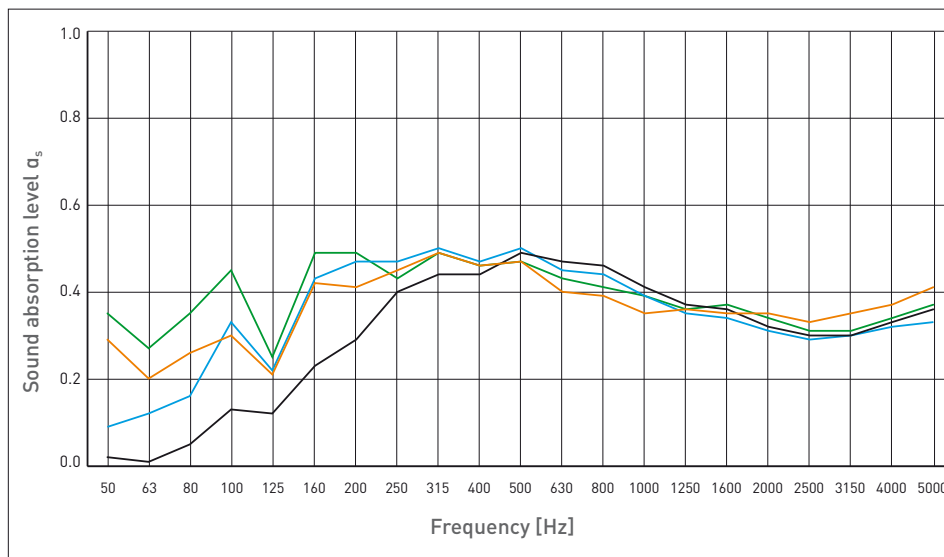

█	H = 70 mm, H _D = 0 mm
█	H = 70 mm, H _D = 50 mm
█	H = 200 mm, H _D = 0 mm
█	H = 200 mm, H _D = 50 mm

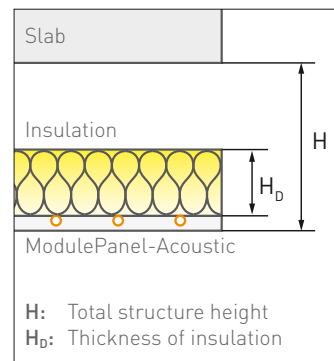

	Hz	50	63	80	100	125	160	200	250	315	400	500	630	800	1000	1250	1600	2000	2500	3125	4000	5000	
H = 70 mm H _D = 0 mm	α _s	0.02	0.01	0.05	0.13	0.12	0.23	0.29	0.40	0.44	0.44	0.49	0.47	0.46	0.41	0.37	0.36	0.32	0.30	0.30	0.33	0.36	α _w : 0.40
	α _p					0.15		0.40		0.45		0.40		0.35		0.35		0.35		0.35			AK: D
H = 70 mm H _D = 50 mm	α _s	0.09	0.12	0.16	0.33	0.22	0.43	0.47	0.47	0.50	0.47	0.50	0.45	0.44	0.39	0.35	0.34	0.31	0.29	0.30	0.32	0.33	α _w : 0.40 (L)
	α _p				0.35		0.50		0.45		0.40		0.30		0.30		0.30		0.30		0.30		AK: D
H = 200 mm H _D = 0 mm	α _s	0.30	0.21	0.26	0.30	0.20	0.43	0.41	0.44	0.49	0.45	0.46	0.39	0.37	0.35	0.36	0.34	0.34	0.31	0.33	0.35	0.42	α _w : 0.40 (L)
	α _p				0.30		0.45		0.45		0.45		0.35		0.35		0.35		0.35		0.35		AK: D
H = 200 mm H _D = 50 mm	α _s	0.35	0.27	0.35	0.45	0.25	0.49	0.49	0.43	0.49	0.46	0.47	0.43	0.41	0.39	0.36	0.37	0.34	0.31	0.31	0.34	0.37	α _w : 0.40 (L)
	α _p				0.40		0.45		0.45		0.45		0.40		0.35		0.35		0.35		0.35		AK: D

α_s = Sound absorption level

α_p = Practical sound absorption level

α_w = Evaluated sound absorption level

Additive (M) Better absorption in the medium frequency range (500 or 1000 Hz)

Additive (L) Better absorption in the low frequency range (250 Hz)

Additive (LM) Better absorption in the medium and low frequency range

AC = Absorber Class

B...Very highly absorbent

C...Highly absorbent

D...Absorbent

E...Low absorbency

B08

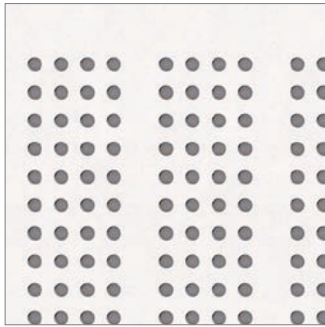

Tested by TÜV Rheinland per DIN EN ISO 354

Data source: LGA/TÜV Rheinland Certificate
Test number: 84129010
Valid for: Ceiling
Fleece: AV 100
Insulation: Rockwool Sonorock or equivalent

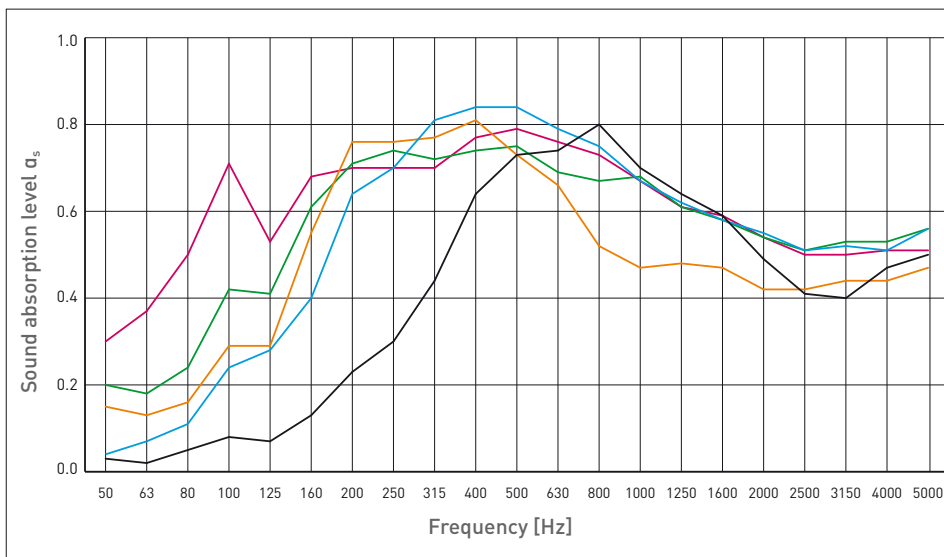

Black	H = 70 mm, H _D = 0 mm
Blue	H = 70 mm, H _D = 50 mm
Orange	H = 200 mm, H _D = 0 mm
Green	H = 200 mm, H _D = 50 mm
Pink	H = 200 mm, H _D = 180 mm

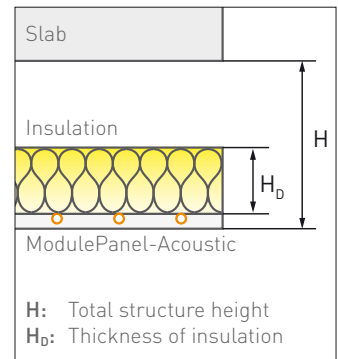

	Hz	50	63	80	100	125	160	200	250	315	400	500	630	800	1000	1250	1600	2000	2500	3125	4000	5000	
H = 70 mm H _D = 0 mm	α _s	0.03	0.02	0.05	0.08	0.07	0.13	0.23	0.30	0.44	0.64	0.73	0.74	0.80	0.70	0.64	0.59	0.49	0.41	0.40	0.47	0.50	α _w : 0.55
	α _p					0.10		0.30		0.70		0.70		0.70		0.50		0.45		0.45		AC: D	
H = 70 mm H _D = 50 mm	α _s	0.04	0.07	0.11	0.24	0.28	0.40	0.64	0.70	0.81	0.84	0.84	0.79	0.75	0.67	0.62	0.58	0.55	0.51	0.52	0.51	0.56	α _w : 0.65 (L)
	α _p				0.30		0.70		0.80		0.70		0.70		0.55		0.55		0.55		0.55		AC: C
H = 200 mm H _D = 0 mm	α _s	0.15	0.13	0.16	0.29	0.29	0.55	0.76	0.76	0.77	0.81	0.73	0.66	0.52	0.47	0.48	0.47	0.42	0.42	0.44	0.44	0.47	α _w : 0.50 (LM)
	α _p				0.40		0.75		0.75		0.75		0.50		0.45		0.45		0.45		0.45		AC: D
H = 200 mm H _D = 50 mm	α _s	0.20	0.18	0.24	0.42	0.41	0.61	0.71	0.74	0.72	0.74	0.75	0.69	0.67	0.68	0.61	0.58	0.54	0.51	0.53	0.53	0.56	α _w : 0.65 (L)
	α _p				0.50		0.70		0.75		0.75		0.65		0.55		0.55		0.55		0.55		AC: C
H = 200 mm H _D = 180 mm	α _s	0.30	0.37	0.50	0.71	0.53	0.68	0.70	0.70	0.70	0.77	0.79	0.76	0.73	0.67	0.61	0.59	0.54	0.50	0.50	0.51	0.51	α _w : 0.60 (L)
	α _p				0.65		0.80		0.75		0.75		0.65		0.55		0.55		0.55		0.50		AC: C

α_s = Sound absorption level

α_p = Practical sound absorption level

α_w = Evaluated sound absorption level

Additive (M) Better absorption in the medium frequency range (500 or 1000 Hz)

Additive (L) Better absorption in the low frequency range (250 Hz)

Additive (LM) Better absorption in the medium and low frequency range

AC = Absorber Class

B...Very highly absorbent

C...Highly absorbent

D...Absorbent

E...Low absorbency

F12

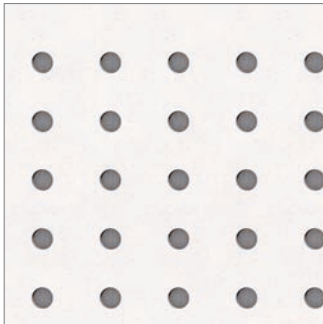

Tested by TÜV Rheinland per DIN EN ISO 354

Data source: LGA/TÜV Rheinland Certificate
Test number: 60233327-001
Valid for: Ceiling
Fleece: AV 100
Insulation: Rockwool Sonorock or equivalent

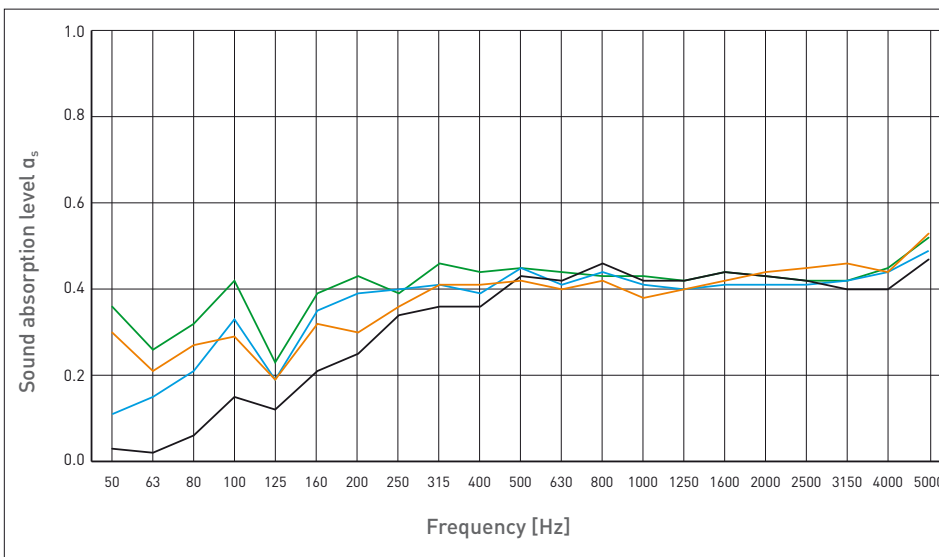

H = 70 mm, H _D = 0 mm
H = 70 mm, H _D = 50 mm
H = 200 mm, H _D = 0 mm
H = 200 mm, H _D = 50 mm

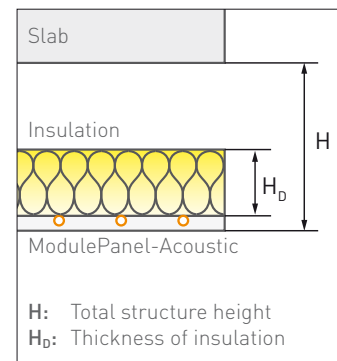

	Hz	50	63	80	100	125	160	200	250	315	400	500	630	800	1000	1250	1600	2000	2500	3125	4000	5000	
H = 70 mm H _D = 0 mm	α_s	0.03	0.02	0.06	0.15	0.12	0.21	0.25	0.34	0.36	0.36	0.43	0.42	0.46	0.42	0.42	0.44	0.43	0.42	0.40	0.40	0.47	α_w : 0.45
	α_p				0.15			0.30		0.40			0.45		0.45			0.45			0.40		AK: D
H = 70 mm H _D = 50 mm	α_s	0.11	0.15	0.21	0.33	0.19	0.35	0.39	0.40	0.41	0.39	0.45	0.41	0.44	0.41	0.40	0.41	0.41	0.41	0.42	0.44	0.49	α_w : 0.40 (L)
	α_p				0.30			0.50		0.40		0.40		0.40		0.40		0.40			0.45		AK: D
H = 200 mm H _D = 0 mm	α_s	0.32	0.22	0.28	0.29	0.18	0.34	0.30	0.36	0.41	0.40	0.41	0.39	0.40	0.38	0.41	0.41	0.43	0.44	0.44	0.42	0.54	α_w : 0.45
	α_p				0.25			0.35		0.40		0.40		0.40		0.45		0.45			0.45		AK: D
H = 200 mm H _D = 50 mm	α_s	0.36	0.26	0.32	0.42	0.23	0.39	0.43	0.39	0.46	0.44	0.45	0.44	0.43	0.43	0.42	0.44	0.43	0.42	0.42	0.45	0.52	α_w : 0.45
	α_p				0.35			0.45		0.45		0.45		0.45		0.45		0.45			0.45		AK: D

α_s = Sound absorption level

α_p = Practical sound absorption level

α_w = Evaluated sound absorption level

Additive (M) Better absorption in the medium frequency range (500 or 1000 Hz)

Additive (L) Better absorption in the low frequency range (250 Hz)

Additive (LM) Better absorption in the medium and low frequency range

AC = Absorber Class

B...Very highly absorbent

C...Highly absorbent

D...Absorbent

E...Low absorbency

10.4 Reverberation time calculator (German only)

With the room acoustic calculator by Trikustik, you can very easily optimise room acoustics and adjust different parameters item by item according to their usage type.

As well as the usage type, room dimensions and the quality of the ceilings and walls, you can try out different scenarios with furniture and the use of different absorbers and test their impact on the reverberation time.

<https://trikustik.at/en/knowledge/reverberation-time-calculator/>

The screenshot displays the Trikustik room acoustic calculator interface. It includes a top graph showing predicted reverberation time (T) in seconds versus frequency (f) in Hz, comparing scenarios with and without absorbers. The middle section contains a control panel with dropdown menus for standards (DIN 18041), usage (Besprechungs-, Sitzungs-, Konferenzraum), and room type (Quader). It also features input fields for room dimensions (Länge l: 5,0 m, Breite b: 7,0 m, Höhe h: 3,0 m, Volumen: 105,0 m³) and material selection for Rohdecke, Rohboden, Bodenbeläge, Wände, Fenster, Möbel für, and Absorber. The bottom section shows a graph of the absorption coefficient (alpha_p) versus frequency (f) in Hz, and a grid of absorber units. The bottom-right section provides product details for the selected absorber: Produkt: 808, MW 0 mm, h = 200 mm; Material: Gipsfaserplatte m. Vlies; Abmessungen: 750 (1000, 1250) x 625 mm, 615 (1240) x 615 mm; Montage: Absorptionsgrad gilt für 200 mm Aufbauhöhe; Brandschutz: -; Bemerkung: Variotherm Heiz- und Kühldecken.

ENJOY THE COMFORT & SAVE ENERGY

That's why our customers love us:

Heating and cooling optimised for COMFORT in all rooms!

Fast and friendly service, ANSWERS backed up with expertise!

Always in tune with the latest technology, INNOVATION guaranteed!

Everything CLEAR and SIMPLE, in writing of course!

PROFESSIONALISM at all times, from the first contact to the reference list!

VARIOTHERM SINCE 1979

Variotherm is an Austrian model plant with hundreds of partners in Austria, Europe and around the world.

All rights pertaining to distribution and translation, in whole or in part, including film, radio, television, video recording, Internet, photocopying and reprinting, are reserved. Subject to mistakes and printing errors. Misprints and errors excepted.



Austria's
Leading
Companies
2014



MCCH



VARIOTHERM HEIZSYSTEME GMBH

GÜNSELSDORFER STRASSE 3A

2544 LEOBERSDORF

AUSTRIA

Phone: 0043 22 56 - 648 70-0

Fax: 0043 22 56 - 648 70-9

office@variotherm.com www.variotherm.com